



— 2024 —

LUXURY SERIES

APEX

ELEMENT

MIRAGE

Coast Spas Manufacturing
6315 202 Street, Langley, BC, Canada
604 514 8111
info@coastspas.com
www.coastspas.com



WORLD'S BEST BUILT SPAS

Here at Coast Spas, we have over 25 years of experience crafting the World's Best Built Spas®. Our mission is to deliver the highest quality spas with exceptional performance to help improve your overall wellness. We are so glad you've chosen the Coast Spa and we hope you; your family and friends all enjoy it for years to come.

Thank you for choosing us!



CONGRATULATIONS!

YOU'RE ALMOST READY TO ENJOY YOUR NEW SPA!

Before you begin to enjoy your spa, please take a moment to submit your spa warranty. For registering your spa, you will need the spa serial number. Picture below will help you locate the serial number on your spa.



You can register your spa by using the link below.
<https://coastspas.microsoftcrmportals.com/>

FOR YOUR REFERENCE

Spa owner name: _____

Address: _____

Contact: _____ Email: _____

Spa Serial number: _____ Purchase Date: _____

Delivery Date: _____ Dealer Name: _____

Contact your spa selling dealer if you have any queries related to your Luxury Spa. Coast Spas authorized dealers are trained professionals who can assist you with spa parts, setup, operations, maintenance, and technical support.

DISCLAIMER: At the time of print, this manual is accurate in its information. Coast Spas reserves all the rights to change/modify any spa designs and/or features without notification. To check on updates or for other information, please visit www.coastspas.com

TABLE OF CONTENTS

Coast Spas Thank You! letter	Page	2
Registering your spa	Page	3
Table of contents	Page	4
Basic information	Page	5
Important safety instructions and glossary of terms	Page	6-8
Luxury Spa general layout	Page	9
Luxury spa collection	Page	10-12
Luxury spa features	Page	13
Start Up Guide— Luxury series	Page	13
Luxury spa care guide	Page	14-16
Basic installation and configuration guidelines: Electrical requirements	Page	17-18
Luxury spa maintenance procedures	Page	18-19
Water clarity troubleshooting	Page	20
Troubleshooting guide	Page	21-22
Draining & Winterizing	Page	23
Luxury spa controls	Page	24
Luxury spa specifications	Page	25
Balboa Wi-Fi module	Page	26
Balboa Wi-Fi module	Page	26
ControlMySpa™	Page	27-30
Balboa Bluetooth Audio (bba™3)	Page	31-33
Coast status	Page	34-35
Coast Spas EcoClean UV sterilizer	Page	36
Luxury spa service log	Page	37-38



PLEASE READ YOUR ENTIRE OWNER'S MANUAL BEFORE SPA OPERATION

Basic Information

Water Care

IMPORTANT: Caring for your water by ensuring proper chemical usage is the single most important thing you can do to keep your Luxury Spa in good condition.

WARNING: Improper chemical usage and maintenance will quickly lead to severe issues with your spa and can affect the spa equipment, jets, pumps, and all other components in contact with the spa water. **All Luxury Spas are susceptible to damage from unbalanced spa water.**

Always maintain your water chemistry within the following parameters.

pH	7.2 - 7.8
Chlorine	1.0 - 3.0 ppm
Bromine	2.0 - 5.0 ppm
Total Alkalinity	100 - 120 ppm
Calcium Hardness	150 - 250 ppm

Electrical

All self-contained spas use 120VAC or 240VAC electrical spa packs.

120VAC: requires an isolated 15 Amp circuit breaker, an isolated circuit with no other appliances or lights on the circuit at any time. Extension cords are not to be used in conjunction with the operations of the spa. Low voltage damage could result, and this is not covered under warranty.

IMPORTANT: Luxury Spas with 110V means that the jets and heater will not work at the same time.

NOTE: All components must be 120V. No 240V components allowable.

240VAC: Depending on the model of the spa, it will require either a 40-, 50-, or 60-Amp dedicated circuit breaker with the proper wire size (gauge) based on the length of the run.

The electrical circuit must be installed by a certified electrician and approved by a local building or electrical inspector.

Surface

Your new portable spa must be placed on a firm, flat, and level surface, so that the weight is supported uniformly. We recommend no less than a 3" (93 mm) thick concrete slab. Wood decking or balconies must be constructed to support 150 pounds per square foot (730 kg/m²). Refer to the local and current building codes in your area. Should your new spa need to go through the gate or space – restricted area, ensure you've communicated those limitations with your dealer to avoid delivery complications.

NOTE: Damage caused by alternate decking methods may avoid the spa warranty. Contact your dealer if you have any questions regarding spa location and placement.

Transport

Your new spa has left the factory cleaned and polished and ready to begin operation after passing our many quality and operational tests. However, depending on your location in the world, your spa may have spent days or even weeks in transit before arriving at your home. Please ensure that before filling or operating your Luxury Spa that you check all electrical and plumbing connections are securely connected in the equipment area as they might have loosened during shipping. If any dirt has accumulated, you will want to remove with a clean cloth or sponge using warm water.

IMPORTANT SAFETY INSTRUCTIONS**READ AND FOLLOW ALL INSTRUCTIONS CAREFULLY**

DANGER: Risk of Injury. The suction fittings in this Luxury Spa are sized to match the specific water flow created by the pump. Should the need arise to replace the suction fittings or the pump, be sure that the flow rates are compatible. Never operate the Luxury Spa if the suction fittings are broken or missing. Never replace a suction fitting with one rated less than the flow rate marked on the original suction fitting.

DANGER: Risk of Accidental Drowning. Do not allow children to be in or around the spa without adult supervision. Keep the spa cover on and locked when not in use. See instructions enclosed with the cover for locking procedures.

DANGER: Risk of Electrical Shock. The electrical supply for this product must include a suitably rated switch or circuit breaker to open all ungrounded supply conductors to comply with section 422-20 of the National Electrical Code, ANSI/NFPA 70. The disconnect must be readily accessible and visible to the Luxury Spa occupant but installed at least 5 feet (1.5 m) from the Luxury Spa water.

READ, FOLLOW AND SAVE THESE INSTRUCTIONS

- a) A green colored terminal or a terminal marked G, Gr, Ground, Grounding, or the symbol * is located inside the supply terminal box or compartment. To reduce the risk of electric shock, this terminal must be connected to the grounding means provided in the electric supply service panel with a continuous copper wire equivalent in size to the circuit conductors that supply this equipment.
- b) At least two lugs marked "Bonding Lugs" are provided on the external surface or on the inside of the supply terminal box compartment. To reduce the risk of electric shock, connect the local common bonding grid around the Luxury Spa to these terminals with an insulated or bare copper conductor no smaller than No. 6 AWG.
- c) All field-installed metal components such as rails, ladders, drains or other similar hardware within 5 feet (1.5 m) of the Luxury Spa shall be bonded to the equipment grounding bus with copper conductors not smaller than No. 6 AWG.

WARNING: To Reduce the Risk of Injury. The water in a Luxury Spa should never exceed 104 °F (40 °C). Water temperatures between 100 °F (38 °C) and 104 °F (40 °C) are considered safe for a healthy adult. Lower water temperatures are recommended for young children and when Luxury Spa use exceeds 10 minutes.

Since excessive water temperatures have a high potential for causing fetal damage during the early months of pregnancy, pregnant or possibly pregnant women should limit Luxury Spa water temperatures to 100 °F (38 °C). If pregnant, please consult your physician before using a Luxury Spa. Before entering the Luxury Spa, the user should measure the water temperature with an accurate thermometer since the tolerance of water temperature regulating devices may vary as much as +/- 5 °F (2 °C). Persons suffering from obesity or a medical history of heart disease, low or high blood pressure, circulatory system problems or diabetes should consult a physician before using a Luxury Spa.

CAUTION: Risk of Hyperthermia. Hyperthermia occurs when the internal temperature of the body reaches a level several degrees above the normal body temperature of 98.6 °F (37 °C). The symptoms of hyperthermia include drowsiness, lethargy, and an increase in the internal temperature of the body. Prolonged immersion in hot water may induce hyperthermia. A description of the causes, symptoms, and effects of hyperthermia are as follows:

- Unawareness of impending hazard.
- Failure to perceive heat.
- Failure to recognize the need to exit Luxury Spa.
- Physical inability to exit Luxury Spa.
- Fetal damage in pregnant women; and
- Unconsciousness and danger of drowning.

WARNING: Children should not use Luxury Spas without adult supervision.

WARNING: Do not use Luxury Spas unless all suction guards are installed to prevent body and hair entrapment.

WARNING: People with infectious diseases should not use a Luxury Spa.

WARNING: To avoid injury, exercise care when entering or exiting the Luxury Spa.

WARNING: Do not use drugs or alcohol before or during the use of Luxury Spa to avoid unconsciousness and possible drowning. The use of alcohol or drugs can greatly increase the risk of fatal hyperthermia in Luxury Spas.

WARNING: Pregnant or possibly pregnant women should consult a physician before using a Luxury Spa.

WARNING: Water temperature more than 38 °C (100 °F) may be injurious to your health. Before entering the Luxury Spa, measure the water temperature with an accurate thermometer.

WARNING: Prolonged immersion in a Luxury Spa may be injurious to your health.

WARNING: Do not permit electric appliances (such as lights, telephone, radio, television, etc.) within 5 feet (1.5m) of this Luxury Spa unless such appliances are built-in by the manufacturer.

WARNING: People using medication and/or having an adverse medical history should consult a physician before using a spa or Luxury Spa.

WARNING: People with infectious diseases should not use a spa or Luxury Spa.

WARNING: To avoid injury, exercise care when entering or exiting the spa or Luxury Spa.

WARNING: Do not use a spa or Luxury Spa immediately following strenuous exercise.

WARNING: Prolonged immersion in a spa or Luxury Spa may be injurious to your health.

WARNING: Maintain water chemistry in accordance with the Manufacturer's instructions.

WARNING: The equipment and controls shall be located no less than 1.5 meters horizontally from the spa or Luxury Spa.

CAUTION: Observe a reasonable time limit when using the Luxury Spa. Long exposures at higher temperatures can cause high body temperature. Symptoms may include dizziness, nausea, fainting, drowsiness, and reduced awareness. These effects could possibly result in drowning.

CAUTION: Enter and exit the Luxury Spa slowly. Wet surfaces can be very slippery.

CAUTION: Proper chemical maintenance of Luxury Spa water is necessary to maintain safe water and prevent possible damage to Luxury Spa components. Maintain water chemistry in accordance with manufacturer's instructions.

CAUTION: Use the straps and clip tie downs to secure the cover when not in use. This will help to discourage unsupervised children from entering the Luxury Spa and keep the Luxury Spa cover secure in high-wind conditions. There is no representation that the cover, clip tie-downs, or actual locks will prevent access to the Luxury Spa.

CAUTION: For exercise, the water should not exceed 90 °F (32 °C).

GLOSSARY OF TERMS



AIR CONTROL: Mounted generally on the lip of the spa, it induces warm air from the equipment enclosure into the jet stream through venturi action.



WATER DIVERTER: The large diverter is used to divert water to various seats in the spa.



FILTER AIR RELIEF VALVE: Located on top of dome filter lid. Used to release air from the filter.



SKIMMER BLEEDER VALVE: Located in the skimmer area, needs to be loosened while filling the spa. This will help eliminate air from being trapped in the spa equipment.



OZONATOR: The ozonator produces natural ozone through the Corona Discharge process. Continuous use of an ozonator can dramatically reduce sanitizer consumption.



CONTROL BOX (Pack): Basically the "heart" of the spa. Power is distributed to any/all functions of the spa: pumps, ozonator, LED lighting, heater element, etc.



TOPSIDE CONTROL: Mounted on the top lip of the spa and controls the functions of the spa.



EQUIPMENT ENCLOSURE: An enclosure that houses the control box, pump(s) and other electrical components.



FILTER: The filter cleans the spa by passing water through a filter cartridge where debris and impurities are removed. Top load filter means the filter cartridge is accessible through the top of the spa. Front access skimmer means cartridge is accessed through door of skimmer.



FLOOR DRAIN: The floor drain is covered by a grate-type cover and is utilized when draining the spa. It also acts as the return for the ozonator. You will see bubbles emitted from this drain, which is the result of water mixing with the ozone output.



GATE VALVES: Red with a grey handle is located at the inlet and outlet of the pumping system. Used while servicing spa equipment, the valves open or close the water flow to the equipment. To remain open for normal use, turn fully counterclockwise.



KNIFE VALVES: A white "T"-handled valve, same functions as Gate valve (see above), except to open them you pull up on handle.



HEATER: The electronically controlled heater raises the temperature of the spa to the desired setting.



LEDs: LEDs and their special lenses can be used to achieve the desired mood lighting in the spa and spa jets.



SKIMMER: This is the rectangular outlet at the water level. The skimmer removes surface debris to the filter. The water level in the spa should be kept $\frac{1}{2}$ to $\frac{3}{4}$ up on the skimmer for optimum operation.

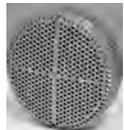

SUCTION: During operation of the equipment, the suction works in conjunction with the skimmer to draw water from the bottom of the spa through the filter, keeping the spa sparkling clean.



NECK JET: Direction-controllable jet for soothing neck massage.



ADJUSTABLE CLUSTER JET: Our adjustable, high-intensity hydrotherapy jet.



DIRECTIONAL JET: Provides a straight flow for a therapeutic massage.



ROTATIONAL JET: Provides a unidirectional circular therapeutic massage.



MASSAGE JET: Delivers massage in staccato bursts over a narrow, focused area.



VOLCANO/WHIRLPOOL JET: high-output jet designed for foot and leg massage.



LAMINAR FLOW: A thin stream of water that arcs from the spa lip.

PREPARATION, SET-UP AND LOCATION FOR YOUR NEW SPA:

- You want to keep in mind how you intend to use the spa and plan the location accordingly.
- How close is the spa from the exit or entrance to your house? (Consider the cold weather)
- Is the path to your spa clean of debris, sand, grass? (So as not to track into the spa)
- Is there protection from wind, inclement weather?
- Can neighbors or passersby see the spa?

NOTE: Allow for service access: Many spa owners enjoy placing their spa in a decorative enclosure or a deck. Keep in mind that you need to have access to equipment for maintenance and the spa should be able to be moved or lifted without destroying the special enclosure or its surroundings. You should discuss this with your dealer when designing the location. Extension cords are not to be used in conjunction with the operations of the spa. Low voltage damage could result, and this is not covered by warranty.

NOTE: All components must be 120V; No 240V components allowable.

240VAC: Depending on the model of spa, it will require either a 40 Amp, 50 Amp, or 60 Amp dedicated circuit breaker, GFCI, with the proper wire size based on the length of the run. The electrical circuit must be installed by a certified electrician and approved by a local building or electrical inspector.

DISCLAIMER: The pictures displayed above are for reference purpose only. Some parts may be different depending upon the spa model.

LUXURY SPA GENERAL LAYOUT (Your spa may look different)



- | | |
|---|----------------------------------|
| 1. Pillows | 11. Laminar Jet Shut Off |
| 2. Air Control | 12. Volcano Jet |
| 3. Extreme XL Water Diverters | 13. Spa Drain |
| 4. Laminar Jets | 14. Spa Lights |
| 5. Hydro Cyclonic Water Filtration System | 15. Suction |
| 6. Poly Jets | 16. 7" Spa Light |
| 7. Cluster Jets | 17. Sweeper Jet |
| 8. Neck Jets | 18. 24" Fusion Waterfall |
| 9. Control Panel | 19. 24" Fusion Waterfall Shutoff |
| 10. Skimmer | 20. Speakers |

DISCLAIMER: At the time of print, this manual is accurate in its information. Coast Spas reserves all the rights to change/modify any spa designs and/or features without notification. To check on updates or for other information, please visit www.coastspas.com

LUXURY APEX SERIES SPA COLLECTION



Luxury Apex Bench



Luxury Apex Lounge



Luxury Apex Bench Curve



Luxury Apex Lounge Curve

DISCLAIMER: At the time of print, this manual is accurate in its information. Coast Spas reserves all the rights to change/modify any spa designs and/or features without notification. To check on updates or for other information, please visit www.coastspas.com

LUXURY ELEMENT SERIES SPA COLLECTION



Luxury Element Bench



Luxury Element Lounge



Luxury Element Bench Curve



Luxury Element Lounge Curve

DISCLAIMER: At the time of print, this manual is accurate in its information. Coast Spas reserves all the rights to change/modify any spa designs and/or features without notification. To check on updates or for other information, please visit www.coastspas.com

LUXURY MIRAGE CURVE SPA



DISCLAIMER: At the time of print, this manual is accurate in its information. Coast Spas reserves all the rights to change/modify any spa designs and/or features without notification. To check on updates or for other information, please visit www.coastspas.com

THE LUXURY SERIES SPAS INCLUDES

Choose model to see specific features and options. All features below may not be included with all models.



Extreme XL Water Diverters LED. Divert the flow of water to specific seats in your Spa.



Air Controls. Allow air to mix with the water being supplied to your massage jets.



Our Luxury **Trillium Jets** are made to deliver the ultimate hydrotherapy experience.



The **Coast Spas Volcano Jet** is installed near the bottom of the Spa and points upward to the surface. This jet is so powerful that it comes standard with its very own diverter valve so that power can be diverted to adjust the intensity.



Coast Spas developed the **Hydro Cyclonic Filtration System**[®]. Not only is it more efficient and faster than a skim filtration system but it also removes the dirty filter canisters from the bathing area.



Your Spa has the ability to be equipped with the **Worldwide Spa Remote** hardware that is required to take advantage of nearly limitless control and monitoring of your Spa.



Coast Spas saves you all the trouble and money with the **Self-Cleaning Sweeper Jet**. The Sweeper Jet is positioned near the spa floor with its fan-like nozzle aimed downwards and is automatically activated on daily filtration cycles.



The raised back of our Curve and Cascade models shelter you from the wind as well as provide a private area in your Spa. The raised back also allows proper placement of our 24"-inch waterfall so the water will cascade over your shoulders like a warm blanket.



Streaming **Water Ropes - Laminars**. Provides the soothing sound of running water. Adds a stunning look to the profile of the Spa.



Extreme[®] Power'sage Zone: Two powerful deep tissue jets where you need them most, targeting areas where we most commonly feel tension.



24" Fusion Waterfall: At one time waterfalls were just to add soothing sounds and a relaxing ambiance to your Spa. Coast Spas[®] changes that by putting you into the waterfall, giving you a feeling of pure relaxation and complete tranquility.



Touchscreen Controls: Color Touch Screen Controls. This easy-to-use control panel features a large multilingual color LCD interface with intuitive icons and animations. There are no buttons to press, just touch the feature you want to control on the touch sensitive screen.

SPA COMFORTS

- Plush Headrests
- Beverage Holders
- Anti-Slip Textured Floor
- Ergonomic Seating
- Multi-Level Seating
- Stainless Steel Oversized Monster[™] Skimmer

BUILT TO LAST[®]

- Programmable Filtration
- Freeze Protection
- Owens Corning[®] Fiberglass Shell with 1 1/4" Steel Reinforcement
- Steel Reinforced Spa Acrylic
- Pressure Treated Frame
- Quick Access Gate Valves
- Recessed Floor Drain
- Recessed Thread-In Jet-Pockets[™]
- Super-Sealed[™] Barb & Clamp Plumbing

DISCLAIMER: The pictures displayed above are for reference purpose only. Some parts may be different depending upon the spa model.

DISCLAIMER: At the time of print, this manual is accurate in its information. Coast Spas reserves all the rights to change/modify any spa designs and/or features without notification. To check on updates or for other information, please visit www.coastspas.com.



START UP GUIDE

Luxury Series

PREP FOR FILLING

! PLEASE READ ALL INSTRUCTIONS BELOW BEFORE FILLING THE SPA



Using a cloth and water, wipe away any dirt/dust collected from transport. Ensure all jets are open by turning the face counterclockwise.



Ensure all plumbing and electrical connections are securely connected and tightened as they can come loose during transit.



Ensure that any gate/knife valves are fully open.



Remove the filter lock ring and lid.



Remove filter and take it out of the plastic transport bag. Leave filter canister open when filling.



Remove skimmer cavity grate cover by sliding it upwards.



Loosen (do not remove) the air bleeder valve located in the skimmer cavity.

FILLING YOUR SPA

! DO NOT USE HOT WATER TO FILL YOUR SPA

! DO NOT USE WATER FROM A WATER SOFTENER



Place fill hose into open filter canister and fill hot tub until water is 2/3 of the way up the skimmer opening.



When filled all massage jets (excluding neck jets) should be under water.



Remove fill hose from filter canister.



Put filter back into filter canister. Then put back on the filter canister lid and tighten the locking ring.

POWERING UP YOUR SPA



Turn the power on at the main breaker.



Turn pump 1 on high speed for 20 seconds by pressing the pump icon twice.

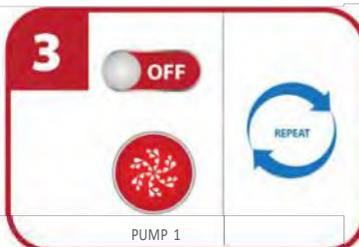

Turn pump 1 off by pressing the pump one icon once. Repeat steps 2 and 3 until air is removed from pump 1 and water is coming from jets.



Tighten the air bleeder valve located in the skimmer cavity. Set your hot tub temperature. Get ready to enjoy!

SPA CARE GUIDE

Your Authorized Dealer carries a wide variety of care and maintenance products. For more information, please contact your Dealer.

REQUIRED FILTER MAINTENANCE

Your new Luxury Spa is equipped with a filter cartridge. To always ensure maximum water quality, you should replace the filter cartridge every six months, or earlier as necessary. The filter cartridge is designed to be thrown away! Attempts to re-use the filter cartridge may result in the re-release of unwanted particles back into the Luxury Spa.

PLEATCO DUAL CORE FILTERS

Your Luxury Spa/spa comes with a premium filter. Most come equipped with a Pleatco DualCore Filter, which does a better job of cleaning your spa water than any other filter cartridge. The DualCore filter has two layers of filtration media, the outer layer, and the inner layer. Both are engineered to remove different particles from your water.



The outer core is like a Luxury filter which traps larger debris, while the inner core filters the water for particles down to 3 microns in size. The inner core is easily removed and both filter media can be cleaned. Keeping your spa water clean and refreshing is extremely important for your enjoyment of your Luxury Spa. Our Luxury Spas come with only the best filters available to ensure your satisfaction.

REQUIRED WATER REPLACEMENT

You should replace the Luxury Spa's water every 3-6 months. The frequency will depend on several variables including frequency of use, number of bathers and attention paid to the water quality maintenance. You will know it is time for a change when you can no longer get the normal feel or sparkle to the water, even though the key water balance measurements are all within the recommended ranges.

HEADREST / PILLOW CARE

The pillows can be removed for easy cleaning and maintenance. All pillows have plugs within the pillow itself. To remove the pillow, grab the bottom edge firmly and pull outward.

This will allow the pillows to pop out from the receptacle in the spa shell. To reinstall the pillow, you will align the pillow plug with the receptacle. Press/hit the front side of the pillow firmly, which will insert the plug back into the receptacle.

- Proper water chemistry must be maintained. Your Luxury Spa pillows are easily and quickly damaged when exposed to unbalanced spa water. If you suspect that your chemicals may be unbalanced, remove your pillows immediately until the water has been restored to the suggested condition.
- Do not sit on the pillows.
- Do not pull on the pillows.
- Pillows should be cleaned using a soft cloth and mild soap, then wiped with a conditioner. We recommend that pillows be washed each time you drain your spa.

This Limited Warranty is void if failure is caused by accident, acts of nature, acts of God, or other causes beyond the control of Coast Spas Manufacturing. Neglect, misuse, and abuse include any installation, operation, or maintenance of the spa other than in accordance with the instructions contained in the owner's manual provided with the spa, including, but not limited to damage caused by operation outside the range of 34°F and 116°F or 1°C and 47°C.

Please be advised that the Spa Warranty will become void if Coast Spas or any of its selling or servicing agents determines that the spa has been exposed to Hydrogen Peroxide, TriChlor or any substance using it as an ingredient proven to be dangerous to the Spa. Any condition arising from the use of Hydrogen Peroxide or TriChlor in the spa is not a warrantable defect.

LUXURY SPA INTERIOR

Your Luxury Spa has a fiberglass reinforced acrylic shell. Generally, dirt and stains will not adhere to the surface. To properly clean the surface, we recommend wiping it with a soft damp cloth (or sponge) using a low sudsing household soap or liquid detergent and rinsing thoroughly with fresh water. Stubborn dirt or stains may be removed by using Spic & Span adequately dissolved in water. Contact your dealer and inquire about maintenance packages.

DO NOT use any cleaning products containing abrasives or solvents, since these could damage the surface. Harsh chemicals should never be used on acrylic surfaces. Damage to the shell due to the use of harsh chemicals is not covered under the warranty.

DO NOT leave your Luxury Spa drained and in direct sunlight for extended periods of time. Extreme heat could cause damage to the acrylic surface and may induce an effect known as "crazing".

STAINLESS STEEL CONTROLS AND COMPONENTS ABOVE THE WATER LINE

To preserve the stainless-steel finish of the controls and components above the water line, we recommend they be wiped with a dry soft cloth after each use of your Luxury Spa. In addition, off-gas your spa by removing the cover for approximately 30 minutes multiple times per week (if not in use) and after every shock treatment.

CABINET CARE

Never spray cabinets with a high-pressure garden hose or pressure washer for any reason. This action may induce an electrical shortage in the Luxury Spa's electrical equipment.

VINYL CABINET

Vinyl cabinets are made of a rigid polymer that combines the durability of plastic with the beauty of real wood. This cabinet is manufactured so that it won't crack, peel, blister or delaminate even after prolonged exposure to the elements. We recommend wiping the cabinet with a soft damp cloth (or sponge) using household soap or liquid detergent and rinsing with fresh water thoroughly. **DO NOT** use abrasive cleansers or material as this may damage the surface.

Vinyl cabinet door opening instructions.



SLATE CABINETS

Optional Slate cabinets are custom-built and painted in our factory. We recommend lightly brushing the cabinet with a **SOFT** bristle brush to remove any dirt or stains. For more information on the care of your Slate cabinet, please contact your local dealer.

Slate cabinet door opening instructions.



COVER CARE

A well cared for spa cover is a thing of beauty. Be sure to clean and condition your cover at least once a month (more often if needed). Your cover needs to be cleaned and conditioned because vinyl can be dry and become brittle, spoiling your spa's appearance.

Dry, brittle vinyl can also tear at the seams and stress points. Quality materials, internal sewn reinforcing and careful workmanship can only go so far against the ravages of Mother Nature. See the specific Warranty card enclosed with your cover for further details.

- When you shock your spa, you need to remove the cover for a minimum of 30 minutes to ensure that the chemical gas can escape from the spa.
- You are required to keep the spa always covered when not in use to protect the shell from harmful UV rays.
- A covered spa will use less electricity when maintaining the desired water temperature.
- See the manual that comes with the cover for proper mounting of the cover locks.
- The cover should always remain locked to prevent unauthorized entry into the spa and potential drowning.
- Do not Sit, Stand or Lie on your cover. Nor should you place any heavy object on top of the cover as this may damage the structure.

VERY IMPORTANT: We recommend a vinyl conditioner for your spa cover. Your local dealer carries a wide variety of care and maintenance products. Choose a pleasant day each month to remove your cover from the spa and lay it on a flat surface accessible by garden hose. Douse the cover with a healthy amount of water from the hose or a bucket to rinse away loose dirt or debris.

Using a soft bristle brush and a mild solution of dish washing liquid (about one teaspoon of detergent to two gallons of water), and with a gentle circular motion, scrub the cover clean. Be careful not to let any areas of the cover dry before they're thoroughly rinsed. Now apply the vinyl conditioner as directed on the container. Massage the conditioner into the cover in a gentle but firm manner. Before replacing the cover on your spa, wipe and rinse any dirt from the bottom of the cover. When you are ready, put the cover on the spa.

NOTE: To remove tree sap, use lighter fluid (not charcoal lighter but the fluid used in cigarette lighters). Use sparingly, then immediately apply conditioner to that area. All waterfalls and laminar flow water features should be turned off when the spa is not in use to avoid heat and water loss.



BASIC INSTALLATION AND CONFIGURATION GUIDELINES

WARNING! Qualified Technician Required for Service and Installation

ELECTRICAL REQUIREMENTS

All self-contained spas use 120VAC or 240VAC electrical spa packs. These instructions describe the only acceptable electrical wiring procedures. Spas wired in any other way will void your warranty and may result in serious injury. All installations should be completed by a certified electrician. Failure to comply with state and local codes may result in fire or personal injury and will be the sole responsibility of the spa owner.

120VAC: This requires an isolated 15 Amp circuit breaker. This needs to be an isolated circuit with no other appliances or lights on this circuit at any time. Extension cords are not to be used in conjunction with the operations of the spa. Low voltage damage could result, and this is not covered by warranty.

NOTE: All components must be 120V; No 240V components allowable.

240VAC: Depending on the model of spa, it will require either a 40 Amp, 50 Amp, or 60 Amp dedicated circuit breaker, GFCI, with the proper wire size based on the length of the run. The electrical circuit must be installed by a certified electrician and approved by a local building or electrical inspector.

Use minimum 6AWG copper conductors only. Torque field connections between 21 and 23 in lbs. Readily accessible disconnecting means to be provided at time of installation. Permanently connected power supply.

Connect only to a circuit protected by a Class A Ground Fault Circuit Interrupter (GFCI) or Residual Current Device (RCD) mounted at least 5' (1.52M) from the inside walls of the spa/Luxury Spa and in line of sight from the equipment compartment.

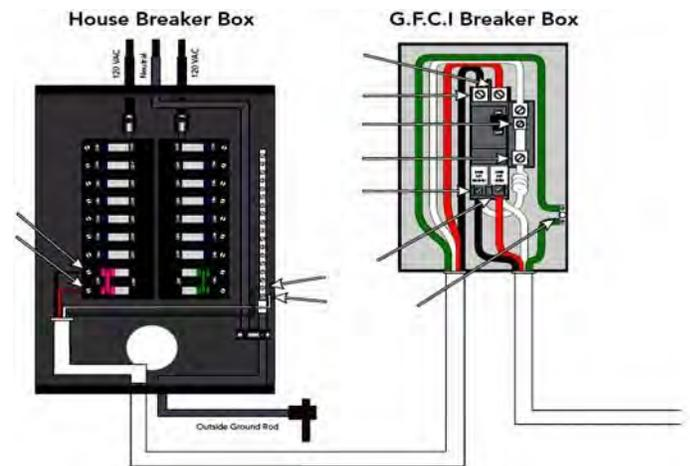

DISCLAIMER: There are no user serviceable parts in the GFCI compartment. All the services and repairs should be performed by certified electrician.

CSA ENCLOSURE: TYPE 2

Refer to Wiring Diagram inside the cover of the control enclosure. Refer to Installation and Safety Instructions provided by the spa manufacturer.

WARNING! GFCI OR RCD PROTECTION.

The Owner should test and reset the GFCI or RCD on a regular basis to verify its function.

WARNING! SHOCK HAZARD! NO USER SERVICEABLE PARTS.

Do not attempt service of this control system. Contact your dealer or service organization for assistance. Follow all owner's manual power connection instructions. Installation must be performed by a licensed electrician and all grounding connections must be properly installed. Disconnect the electric power before servicing. Keep the access door closed.

CSA COMPLIANCE**CAUTION:**

- Test the ground fault circuit interrupter before each use of the spa.
- Read the instruction manual.
- Adequate drainage must be provided if the equipment is to be installed in a pit.
- For use only within an enclosure rated CSA Enclosure 3.
- Connect only to a circuit protected by a Class A ground fault circuit interrupter or residual current device.
- To ensure continued protection against shock hazard, use only identical replacement parts when servicing.
- Install a suitably rated suction guard to match the maximum flow rate marked.

WARNING:

- Water temperatures more than 38°C (100.4°F) may be injurious to your health.
- Disconnect the electrical power before servicing.

CAUTION: When using this electrical equipment, basic safety precautions should always be followed.

LUXURY SPA MAINTENANCE PROCEDURES**FILTER MAINTENANCE**

The spa filter is one of the most important maintenance items of a Cascade Spa. The filter is there to remove debris from the water and needs to be cleaned on a regular basis. Failure to do so may result in poor performance, poor water clarity and could prevent the spa from heating. Filtration starts as soon as flow is steady through the filter. As the filter cartridge removes the debris from the spa water, the accumulated debris causes flow resistance.

CLEANING AND REPLACING FILTER CARTRIDGE

Your spa filter has been designed for quick and easy maintenance. The filter cartridge should be rinsed by hose once a week and cleaned with a cartridge cleaner once a month. A second filter cartridge is recommended and will speed up this process. This can be purchased from your local dealer.

**TOP LOAD FILTERS**

- Turn the power OFF at the breaker.
- Loosen air relief valve, then remove retainer ring.
- Pull filter lid straight up to remove.
- Do not twist or pull the filter lid up at an angle. This could cause damage to the filter canister, especially in freezing conditions.
- Remove filter cartridge and clean with a garden hose and a high-pressure nozzle. Periodically you may need to soak your filter in a "cartridge filter cleaner" to remove excess minerals and/or oils.
- Rinse filter thoroughly before installing. Clean the O-ring on filter lid and apply a light film of silicone lubricant to the O-ring. Do not use a petroleum-based lubricant as it could damage the ring. Consult your dealer to purchase suitable lubricant.
- Place clean Cartridge in filter canister.
- Replace filter lid and re-tighten retaining ring (finger tight only)

NOTE: Make sure the O-ring is on the air relief valve and is finger tight prior to starting the pump. This O-ring should periodically be lubricated with a silicone lubricant.

- There is a 3/8" clear line coming from the filter area, and this goes to the bottom corner of the spa. This drains all the water from around the filter canister.
- This is a good time to check the skimmer basket. Bring skimmer door (weir) forward and unscrew basket. Clean out debris and reinstall.

WATER QUALITY MAINTENANCE

Maintaining the quality of the water within the specified limits will serve to enhance your enjoyment and prolong the life of the Luxury Spa's equipment. It is a simple task, but it requires regular attention because the water chemistry involved is a balance of several factors. There is no simple formula, and there is no avoiding it. An indifferent approach to water maintenance will result in poor and potentially harmful conditions for soaking and even damage to your Luxury Spa investment. The most important thing to keep in mind is that *preventing* poor water chemistry is much easier than *correcting* poor water chemistry. For specific guidance on maintaining water quality, consult your Authorized Dealer who can recommend appropriate chemical products for sanitizing and maintaining your Luxury Spa.

MAINTAIN HEALTHY SPA WATER

Important! When maintaining your Luxury Spa's water chemistry, ensure that your cover is removed during any aggressive treatments to allow for dissipation into the air. Take care to remove the cover slowly and let chemicals deplete if you are uncertain if your water is properly balanced. ***Always maintain your Luxury Spa's water chemistry within the following parameters:***

pH: pH is a measure of relative acidity or alkalinity of water and is measured on a scale of 0 to 14. The midpoint of 7 is said to be neutral, above which is alkaline and below which is acidic. In Luxury Spa water, it is very important to maintain a slightly alkaline condition of 7.2 to 7.8. Problems become proportionately severe the further outside of this range the water gets. A low pH will be corrosive to metals in the Luxury Spa equipment. A high pH will cause minerals to deposit on the interior surface (scaling), cloudy water, and a prematurely dirty filter. In addition, the ability of the sanitation agents to keep the Luxury Spa clean is severely affected as the pH moves beyond the ideal range. That is why almost all Luxury Spa water test kits contain a measure for pH as well as sanitizer. DO NOT use strong acids like Hydrochloric acid or Muriatic acid to balance the pH as it could severely damage the spa shell.

Sanitizer (Chlorine or Bromine): To destroy bacteria and organic compounds in the Luxury Spa water by breaking them down into non-harmful levels which get filtered out. A sanitizer must be used regularly, either chlorine or bromine. Sanitizing your spa water is the most important spa maintenance you can do for yourself.

Total Alkalinity (TA) is the measure of the dissolved alkaline agents such as carbonates and bicarbonates. These alkaline agents help prevent rapid changes in pH by acting as a pH buffer.

Controlling alkalinity can help keep your pH in the appropriate range thereby lessening the need for pH balancing. If the TA is too low the pH level will fluctuate rapidly from high to low. If the TA is too high the pH will tend to be too high and will be very difficult to bring back down.

Calcium Hardness: This is a measurement of dissolved calcium in the water. Calcium will help control the corrosive nature of the spa's water. Low calcium hardness causes spa and equipment corrosion whereas high calcium hardness results in cloudy water and scale build-up on the spa and the equipment.

WARNING: Never store chemicals inside the equipment area of your spa.

IMPORTANT: DO NOT use Hydrogen Peroxide based sanitizers in your spa. When using Chlorine or Bromine tablets you must use a floating dispenser. These chemicals can have an extremely corrosive effect on certain materials in the spa. Damage caused using these chemicals, or improper use of any chemicals, is not covered under the spa's warranty.

OTHER ADDITIVES: Many other additives are available for your spa. Some are necessary to compensate for out-of-balance water, some aid in cosmetic water treatment and others simply alter the feel or smell of the water. Your Authorized Dealer can advise you on the use of these additives.



Look for these specialized cleaning attachments at your local dealership.

WATER DIVERTER MAINTENANCE

CAUTION: Turn off the spa from main GFCI breaker to carry out any maintenance procedures.

Steps to clean water diverters:

1. Pull the diverter cap off and rotate the diverter body counterclockwise and pull out the assembly (Picture 1a to 1c).
2. Using clean piece of cloth, remove the dust particles or depositions (Picture 2).

3. Assemble the diverter body by inserting the body back by rotating the jet body clockwise (Picture 3a and 3b). Attach the diverter cap.

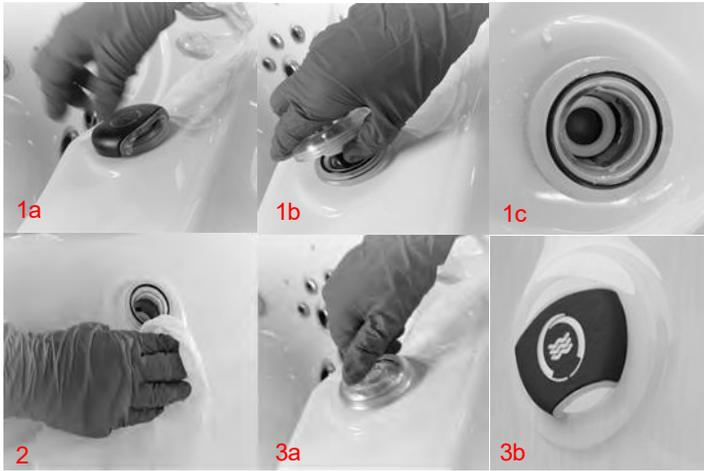

JET MAINTENANCE

CAUTION: Turn off the spa from main GFCI breaker to carry out any maintenance procedures.

It is important to regularly clean the jets to prevent any unwanted depositions and potential damage to the plumbing. It is the responsibility of the customer to regularly perform the maintenance procedures. To clean and maintain optimum jet functions, follow the maintenance instructions below.

LAMINAR FLOW JET MAINTENANCE INSTRUCTIONS

1. Rotate counterclockwise and pull out the jet body (Picture 1a and 1b).
2. Using clean piece of cloth, remove the dust particles or debris (Picture 2).
3. Remove the unreachable debris with the help of vacuum cleaner (Picture 3).
4. Assemble the jet insert back by rotating the jet body clockwise (Picture 4a and 4b).

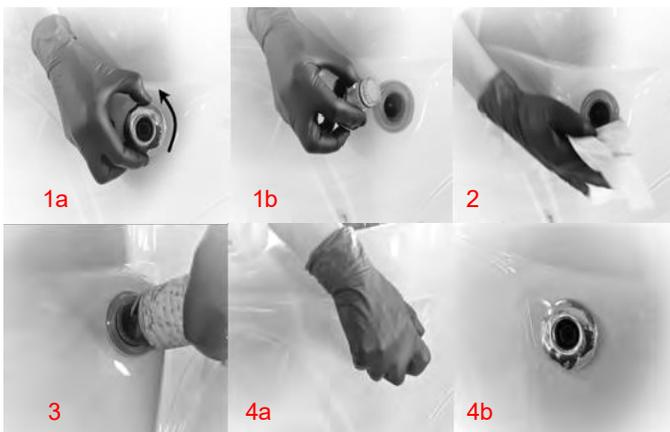

WATER CLARITY TROUBLESHOOTING

PROBLEM	PROBABLE CAUSE	POTENTIAL SOLUTIONS
Water Odor	<ul style="list-style-type: none"> • Improper sanitization • Excessive organics in water • pH is too low 	<ul style="list-style-type: none"> > Add sanitizer > Shock spa with sanitizer > Adjust pH
Chlorine Odor	<ul style="list-style-type: none"> • Chloramines are too high • pH is too low 	<ul style="list-style-type: none"> > Shock spa with sanitizer > Adjust pH
Musty Odor	<ul style="list-style-type: none"> • Bacteria or Algae growth 	<ul style="list-style-type: none"> > Shock spa with sanitizer > Drain and refill spa water
Scale	<ul style="list-style-type: none"> • Total alkalinity is too high • pH is too high • High calcium content in water 	<ul style="list-style-type: none"> > Adjust total alkalinity > Adjust pH > Use stain and scale product
Stains	<ul style="list-style-type: none"> • Total alkalinity is too low • pH is too low • High metal content in water 	<ul style="list-style-type: none"> > Adjust alkalinity > Adjust pH > Use stain and scale product
Cloudy Water	<ul style="list-style-type: none"> • Poor filtration • pH is too high • Hardness is too high • Total alkalinity is too high • Suspended particles 	<ul style="list-style-type: none"> > Clean filter cartridge > Adjust pH > Adjust hardness > Adjust total alkalinity > Drain and refill spa water
Algae Growth	<ul style="list-style-type: none"> • pH is too high • Sanitizer is too low 	<ul style="list-style-type: none"> > Adjust pH > Shock spa with sanitizer > Adjust sanitizer level
Eye Irritation	<ul style="list-style-type: none"> • pH is too low • Sanitizer is too low 	<ul style="list-style-type: none"> > Adjust pH > Shock spa with sanitizer > Adjust sanitizer level
Skin Rash/Irritation	<ul style="list-style-type: none"> • Free chlorine level too high • Unsanitary water 	<ul style="list-style-type: none"> > Adjust chlorine level > Shock spa with sanitizer > Adjust sanitizer level

TROUBLESHOOTING GUIDE

SPA SYSTEM

SYMPTOM	PROBABLE CAUSE	RECOMMENDED ACTION
Spa does not work	<ul style="list-style-type: none"> Power is turned off 	<ul style="list-style-type: none"> > Reset GFCI
No display on the control panel	<ul style="list-style-type: none"> Power is turned off Defective topside control 	<ul style="list-style-type: none"> > Reset GFCI > Contact your Dealer
Letters on the control panel	<ul style="list-style-type: none"> An error has been found 	<ul style="list-style-type: none"> > Refer to the Reference Card for your control panel to verify the error. Contact your Dealer for service

PUMP PROBLEMS

SYMPTOM	PROBABLE CAUSE	RECOMMENDED ACTION
Noisy/Loud motor	<ul style="list-style-type: none"> Air trapped in the pump Low water level Worn pump seal Defective pump 	<ul style="list-style-type: none"> > Open bleed valve in the skimmer > Add water to the spa > Contact your Dealer > Contact your Dealer
Pumps power down on their own	<ul style="list-style-type: none"> Set temperature has been reached Filtration cycle has ended Automatic time out Overheat safety protection 	<ul style="list-style-type: none"> > No problem > No problem > Pumps are set to run for a predetermined time while the spa is in use (15-20 Mins) > The pumps have a thermal overload which will prevent them from running for extended periods of time. Wait until pumps have cooled down (1+ hrs). If problem persists, contact your Dealer.
Pump running constantly, will not turn off	<ul style="list-style-type: none"> Filter cycle set to 24 hours Problem with the circuit board 	<ul style="list-style-type: none"> > Turn off 24 hour filtration > Turn power off at GFCI and contact your Dealer
Pump will not turn on	<ul style="list-style-type: none"> GFCI tripped Motor has overheated Not plugged in Damaged plug Seized motor Blown fuse Motor vent is blocked 	<ul style="list-style-type: none"> > Reset the GFCI > Let cool for 1+ hour > Plug in to the board > Contact your Dealer > Contact your Dealer > Check fuse or contact your Dealer > Clear debris from the vent

HEAT PROBLEMS	PROBABLE CAUSE	RECOMMENDED ACTION
Water will not heat	<ul style="list-style-type: none"> • Error message on control panel • Spa is in a different Heat Mode • Water level is too low • Poor water flow • Closed valves • Pump 1 is not running 	<ul style="list-style-type: none"> > Refer to the Reference Card for your control panel to verify the error > Set spa to "Standard Mode" > Add water to the spa > Clean filter & check valves > Open all valves > Contact your dealer
Water is too hot	<ul style="list-style-type: none"> • Incorrect reading • Filter cycle duration is too long • Pump speeds reversed 	<ul style="list-style-type: none"> > Verify temperature with thermometer > Reduce duration of the filter cycle > Contact your dealer
Water will not maintain heat	<ul style="list-style-type: none"> • Cover is off for extended periods of time in cold weather / cold wind. • Hot tub is wired for 110V and jets are on. 	<ul style="list-style-type: none"> > Put cover back onto hot tub and allow for heat to regenerate. Call your dealer if temperature does not increase. > Hot tubs wired for 110V only have enough power to heat or operate pumps. Turn off jets to power heater.

LIGHTING ISSUES	PROBABLE CAUSE	RECOMMENDED ACTION
Standard light will not come on	<ul style="list-style-type: none"> • Bulb has burnt out 	<ul style="list-style-type: none"> > Replace the light bulb
LED lighting not in sync	<ul style="list-style-type: none"> • Burnt out bulb/connection 	<ul style="list-style-type: none"> > Contact your dealer
LED lighting won't come on	<ul style="list-style-type: none"> • Incorrect settings 	<ul style="list-style-type: none"> > Contact your dealer

PUMPS WILL NOT PRIME	PROBABLE CAUSE	RECOMMENDED ACTION
Pump on but no water flow	<ul style="list-style-type: none"> • Air trapped in pump • No water in the pump • Closed valves 	<ul style="list-style-type: none"> > Loosen bleed valve in skimmer > Check the fill level in the spa > Open all valves

HYDROTHERAPY JETS	PROBABLE CAUSE	RECOMMENDED ACTION
Little to no water flowing from jets	<ul style="list-style-type: none"> • Jets turned off • Pump not primed • Valves are closed • Diverter set to a different seat • Dirty filter 	<ul style="list-style-type: none"> > Open jet by turning the face counterclockwise. > Reset breaker to allow for the spa to prime the pump. Open bleed valve in the skimmer area > Open valves > Switch diverter > Remove and clean filter cartridge

PLUMBING SYSTEM	PROBABLE CAUSE	RECOMMENDED ACTION
Water around base of spa	<ul style="list-style-type: none"> • Loose connections • Leak from internal fitting 	<ul style="list-style-type: none"> > Hand tighten all quick disconnects and fittings. > Check gaskets and O-rings > Contact your dealer

DRAINING AND WINTERIZING

DRAINING YOUR SPA

After a period of 3-4 months, detergent residues from bathing suits and soap film will build up in your spa water. Once this happens, your spa water will appear cloudy and should probably be replaced.

- Turn the power OFF at the breaker.
- Locate the drain valve (usually in the equipment area).
- Remove the safety cap and attach the garden hose.
- Drain water to a convenient area. (Spa water may harm grass or plants if sanitizer levels are high.)
- When water begins to flow out of the hose, open the air relief valve located on filter lid (Hydro-Cyclonic Filtration) or Air Bleeder Valve (Skim Filtration).
- Your spa will drain except for a small portion left in the foot well. This can be removed with a sponge and pail.
- Once empty, clean as required.
- To finish, remove the garden hose and attach safety cap.



WINTERIZING YOUR SPA

In many areas of the world the temperature may drop below 32° F (0°C). We recommend the spa is always filled with water and running at normal spa temperatures. By doing this you will minimize the risk of freezing within your spa. If it is necessary to leave your spa unattended for long periods of time during cold weather conditions, you should drain your spa to avoid accidental freezing caused by power outages.

Your local dealer can perform the following winterizing procedures if you are not completely comfortable with them.

- Ensure that you have fully drained the spa (Refer to the DRAINING YOUR SPA section)
- After draining, your spa may still have water remaining in the equipment and plumbing fittings. Disconnect the hand-tightened union fittings going to and from the jet pumps. Be careful not to lose the O-rings between the unions and pump housing.

- Leave drain valve in the open position and safety cap off.
- To completely drain the plumbing lines, a wet/dry shop vacuum can be used to draw out any remaining water. Place the vacuum hose over the jet fittings in the spa as well as the plumbing lines in the equipment area. You should also disconnect the plug on the crystal-clear inspection tube (if installed)
- Remove the filter cartridge and store in a warm, dry area.
- Clean the spa shell and place spa cover on spa. Be sure to lock the cover in place in case of high winds or rain.

WARNING: The instructions above should be followed accordingly when winterizing your spa. However, they are guidelines and potential freeze damage may still occur. Freeze damage is the sole responsibility of the spa owner and will not be covered by the warranty should it occur.

EMERGENCY SITUATIONS: To eliminate freezing in the event of equipment failure, use a 100-watt light bulb or small heater via extension cord and place it in the equipment area, keeping it away from plumbing lines. This will help for a short period of time until proper service can be rendered.



DRAINING INSTRUCTIONS

1. On the control panel (settings) select **hold**. This will suspend all functions so that the spa can start to be drained.
2. Remove the false bottom in cabinet area.
3. Connect your hose to the hose bib located in the lower compartment. Open the hose bib valve until water starts coming out of the drain hose.
4. Turn evacuation pump power switch ON - located at the top left of the enclosure.
5. The length of time it will take to drain depends on the size of your spa. On average it will take approximately 1 hour.

If you have an Infinity Edge Spa allow it to drain for 30 minutes and then take it off of **hold**. Pump 1 will run on low speed to drain the tank into the main body of the spa.

Let pump 1 run on low speed until the water stops coming out of the jets/waterfall and immediately put the system back into **hold** (refer to step one).

6. Allow spa to finish draining. When fully drained, switch off the evacuation pump and close the hose bib valve.
7. Switch off power to the spa via the main GFCI Breaker.
8. You may have to use a shop vacuum to remove any excess water. Clean the spa before refilling. Refer to your Owner's Manual for proper filling instructions. Once the spa is filled, **prior to adding chemicals**, open the hose bib valve for approx. 15 seconds to allow fresh water to flush the Water-Vac™ System then close the hose bib valve.

IMPORTANT PLEASE READ

Do not leave your spa unattended while draining. After 90 minutes the hold function is disabled and will allow your spa pumps to activate. This could cause damage to your equipment.

LUXURY SERIES CONTROL PANEL



Please click on the link below or scan the QR code to download the Control Panel user guide.

<https://www.balboawatergroup.com/getdoc.cfm?id=2563>



LUXURY SPA SPECIFICATIONS 14" AND VLUX CORNERS

Series	Model	Seat	Dims (cm)	Dims (in)	Capacity (l)	Capacity (us gal)	Dry wt (kg)	Dry Wt (lbs)	Wet Weight (kg)	Wet Weight (lbs)
Luxury	Apex Bench	7	234 X 234 X 101.5	92 X 92 X 40	1552	410	672	1482	2224	4903
Luxury	Element Bench	6	212 X 212 X 101.5	83.5 X 83.5 X 40	1268	335	420	925	1688	3721
Luxury	Apex Lounge	6	234 X 234 X 101.5	92 X 92 X 40	1496	395	672	1482	2168	4780
Luxury	Element Lounge	5	212 X 212 X 101.5	83.5 X 83.5 X 40	1210	320	420	925	1630	3594

Series	Model	Seat	Dims (cm)	Dims (in)	Capacity (l)	Capacity (us gal)	Dry wt (kg)	Dry Wt (lbs)	Wet Weight (kg)	Wet Weight (lbs)
Luxury	Apex Bench Curve	7	234 X 234 X 101.5 (119.5 at back)	92 X 92 X 40 (47 at back)	1552	410	672	1482	2224	4903
Luxury	Element Bench Curve	6	212 X 212 X 101.5 (119.5 at back)	83.5 X 83.5 X 40 (47 at back)	1268	335	420	925	1688	3721
Luxury	Apex Lounge Curve	6	234 X 234 X 101.5 (119.5 at back)	92 X 92 X 40 (47 at back)	1496	395	672	1482	2168	4780
Luxury	Element Lounge Curve	5	212 X 212 X 101.5 (119.5 at back)	83.5 X 83.5 X 40 (47 at back)	1210	320	420	925	1630	3594
Luxury	Mirage Curve	8	335 X 234 X 101.5 (119.5 at back)	132 X 92 X 40 (47 at back)	2234	590	748	590	3322	7324

DISCLAIMER: At the time of print, this manual is accurate in its information. Coast Spas reserves all the rights to change/modify any spa designs and/or features without notification. To check on updates or for other information, please visit www.coastspas.com

LUXURY SPA JET OPERATIONS

LUXURY APEX BENCH 65 JETS WITHOUT DOME

	PUMP 1
	PUMP 2
	PUMP 3

JET Note:

∅	= Cluster Jet
R	= Poly Jet
2K	= Storm Jet
2KV	= Volcano Jet
C.J	= Carousel Jet

Diverter Control

	= Green (Right)
	= Orange (Left)
(P2)	= Both (Center)
	= Yellow (Right)
	= Magenta (Left)
(P3)	= Both (Center)

Air Control General Note:

ON  **OFF**
 (BLUE, ORANGE, GREEN, MAGENTA, YELLOW)

L.F. Shutoff & (Optional C.C Shutoff)

ON  **OFF**
 (BLUE)

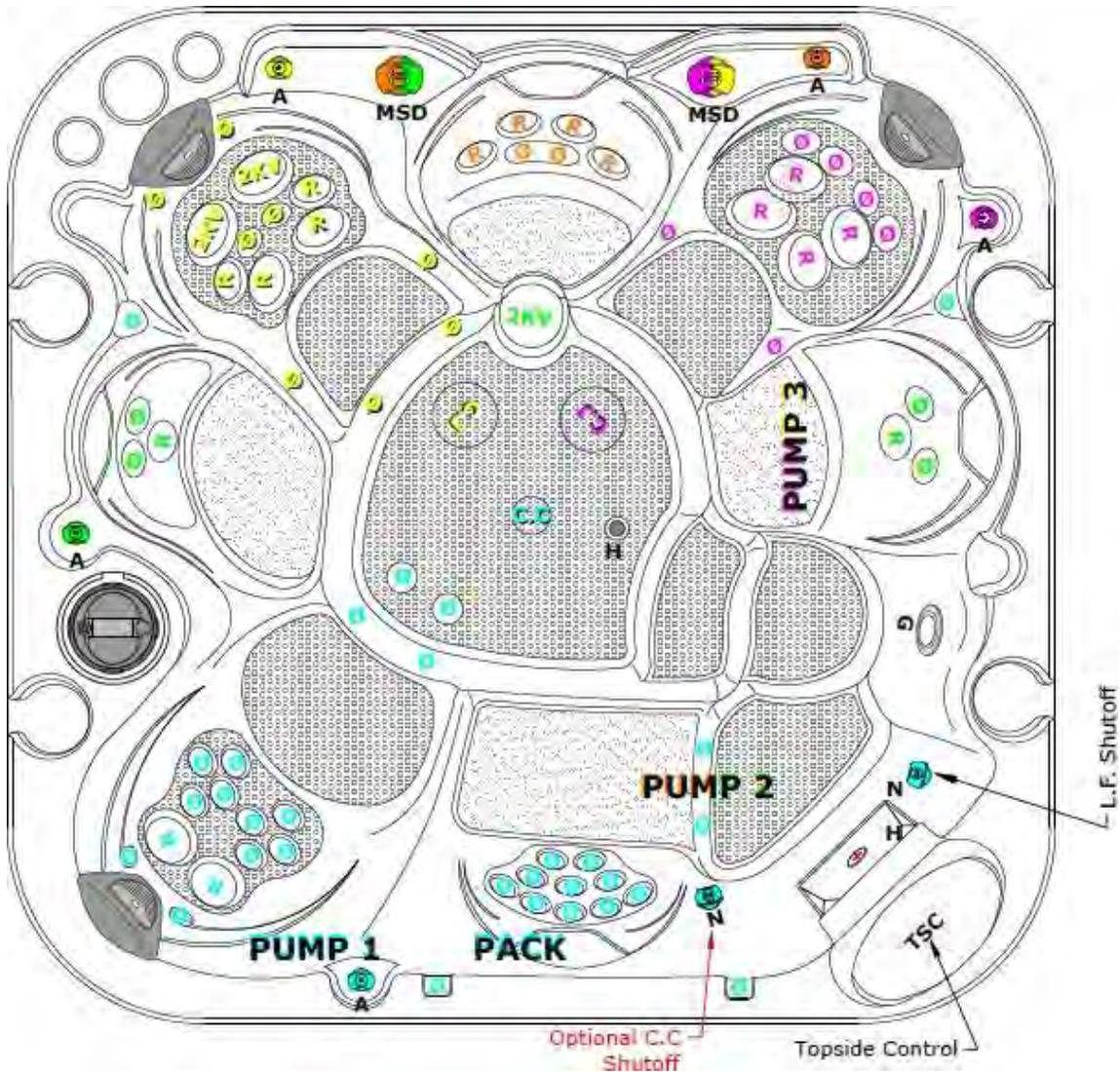

DISCLAIMER: At the time of print, this manual is accurate in its information. Coast Spas reserves all the rights to change/modify any spa designs and/or features without notification. To check on updates or for other information, please visit www.coastspas.com

LUXURY SPA JET OPERATIONS

LUXURY APEX BENCH 65 JETS WITH DOME

	PUMP 1
	PUMP 2
	PUMP 3

JET Note:

∅	= Cluster Jet
R	= Poly Jet
2K	= Storm Jet
2KV	= Volcano Jet
C.J	= Carousel Jet

Diverter Control

	= Green (Right)
	= Orange (Left)
(P2)	= Both (Center)
	= Yellow (Right)
	= Magenta (Left)
(P3)	= Both (Center)

Air Control General Note:

ON  **OFF**
 (BLUE, ORANGE, GREEN, MAGENTA, YELLOW)

L.F Shutoff & (Optional C.C Shutoff)

ON  **OFF**
 (BLUE)

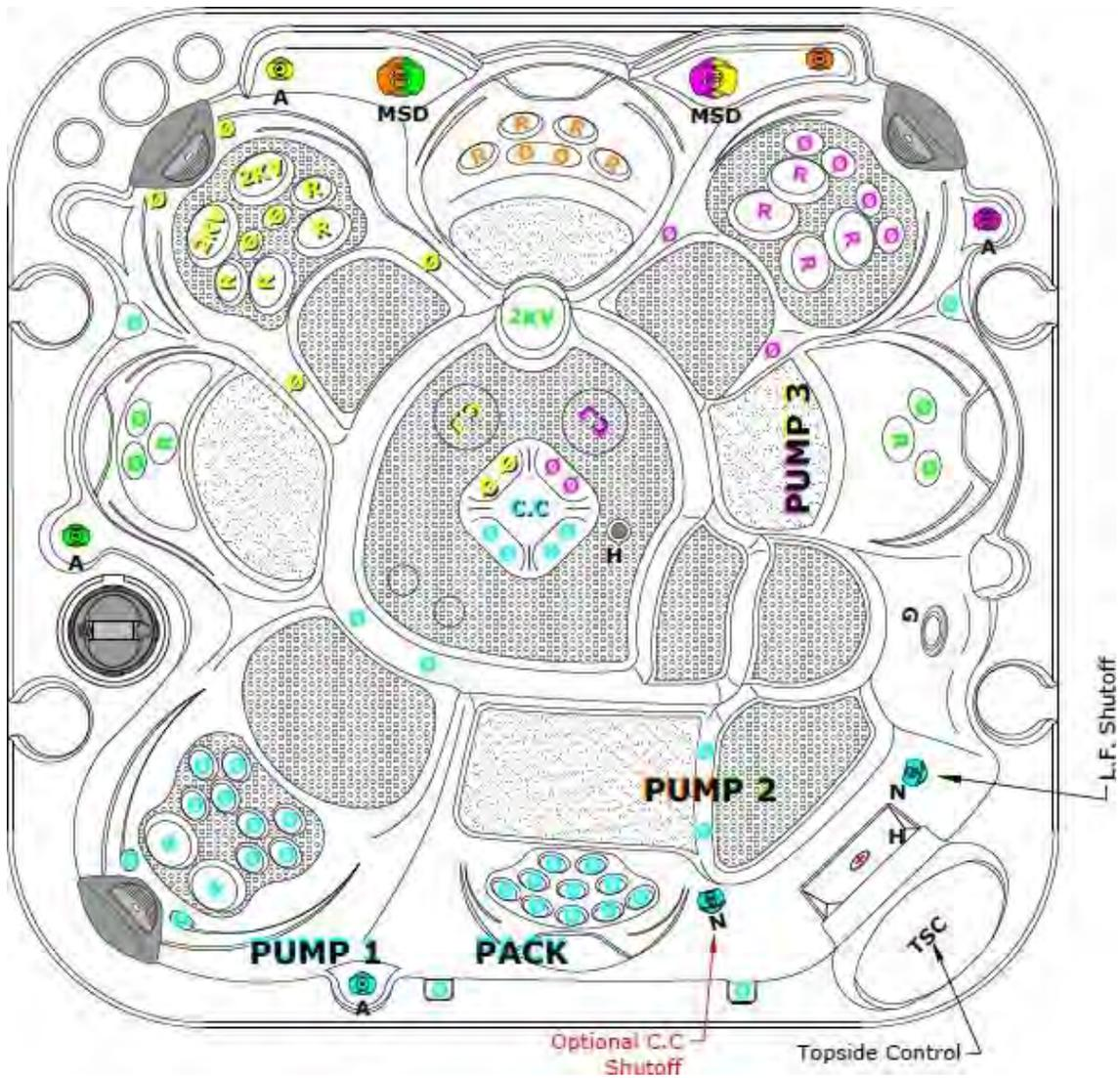

DISCLAIMER: At the time of print, this manual is accurate in its information. Coast Spas reserves all the rights to change/modify any spa designs and/or features without notification. To check on updates or for other information, please visit www.coastspas.com

LUXURY SPA JET OPERATIONS

LUXURY APEX BENCH CURVE 65 JETS WITHOUT DOME

	PUMP 1
	PUMP 2
	PUMP 3

JET Note:	
Ø	= Cluster Jet
R	= Poly Jet
2K	= Storm Jet
2KV	= Volcano Jet
C.J	= Carousel Jet

Diverter Control	
	= Green (Right)
	= Orange (Left)
(P2)	= Both (Center)
	= Yellow (Right)
	= Magenta (Left)
(P3)	= Both (Center)

Air Control General Note:

ON  **OFF**
 (BLUE, ORANGE, GREEN, MAGENTA, YELLOW)

L.F Shutoff & (Optional C.C Shutoff)

ON  **OFF**
 (BLUE)

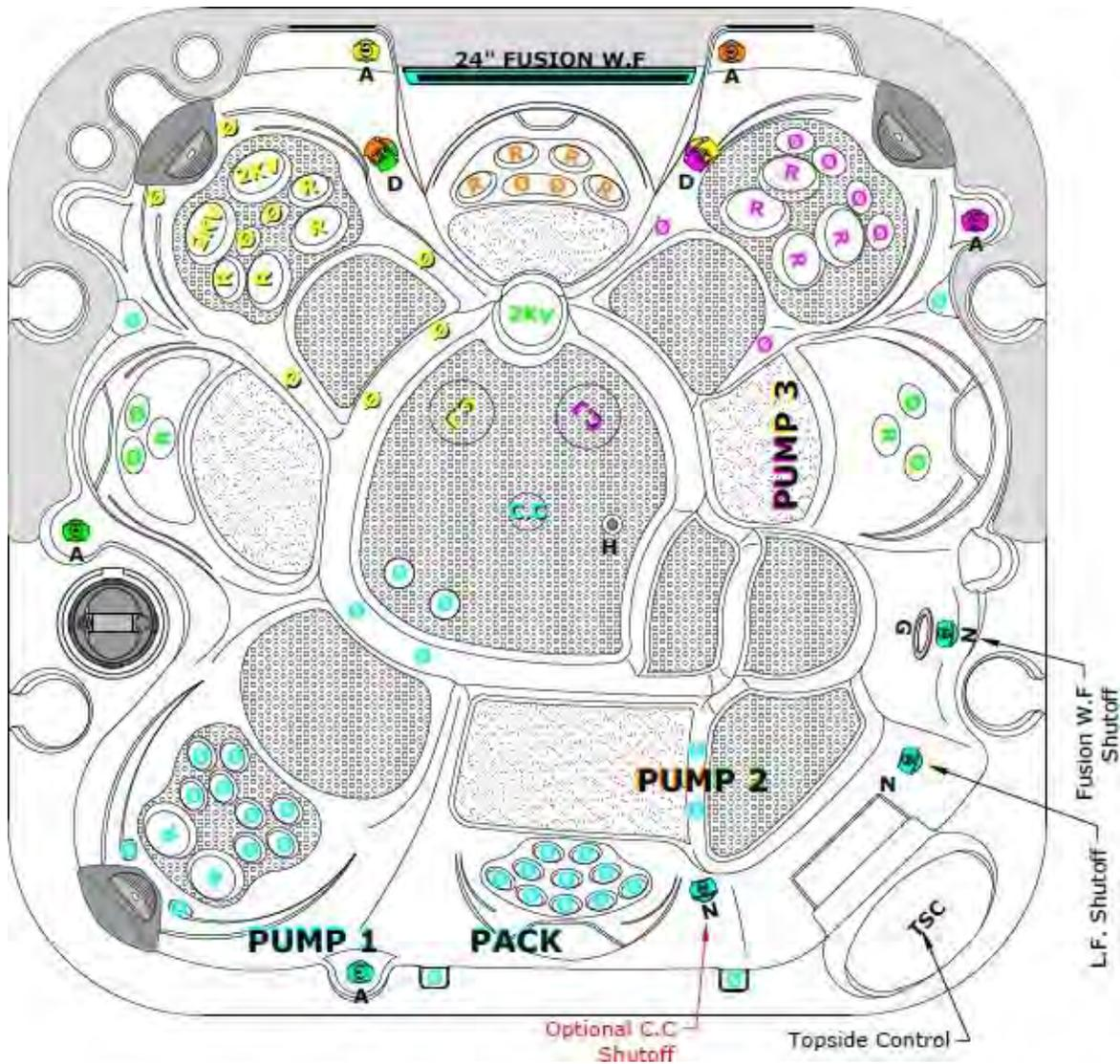

DISCLAIMER: At the time of print, this manual is accurate in its information. Coast Spas reserves all the rights to change/modify any spa designs and/or features without notification. To check on updates or for other information, please visit www.coastspas.com

LUXURY SPA JET OPERATIONS

LUXURY APEX BENCH CURVE 65 JETS WITH DOME

	PUMP 1
	PUMP 2
	PUMP 3

JET Note:

∅	= Cluster Jet
R	= Poly Jet
2K	= Storm Jet
2KV	= Volcano Jet
C.J	= Carousel Jet

Diverter Control

	= Green (Right)
	= Orange (Left)
(P2)	= Both (Center)
	= Yellow (Right)
	= Magenta (Left)
(P3)	= Both (Center)

Air Control General Note:

ON  **OFF**
 (BLUE, ORANGE, GREEN, MAGENTA, YELLOW)

L.F. Shutoff & (Optional C.C. Shutoff)

ON  **OFF**
 (BLUE)

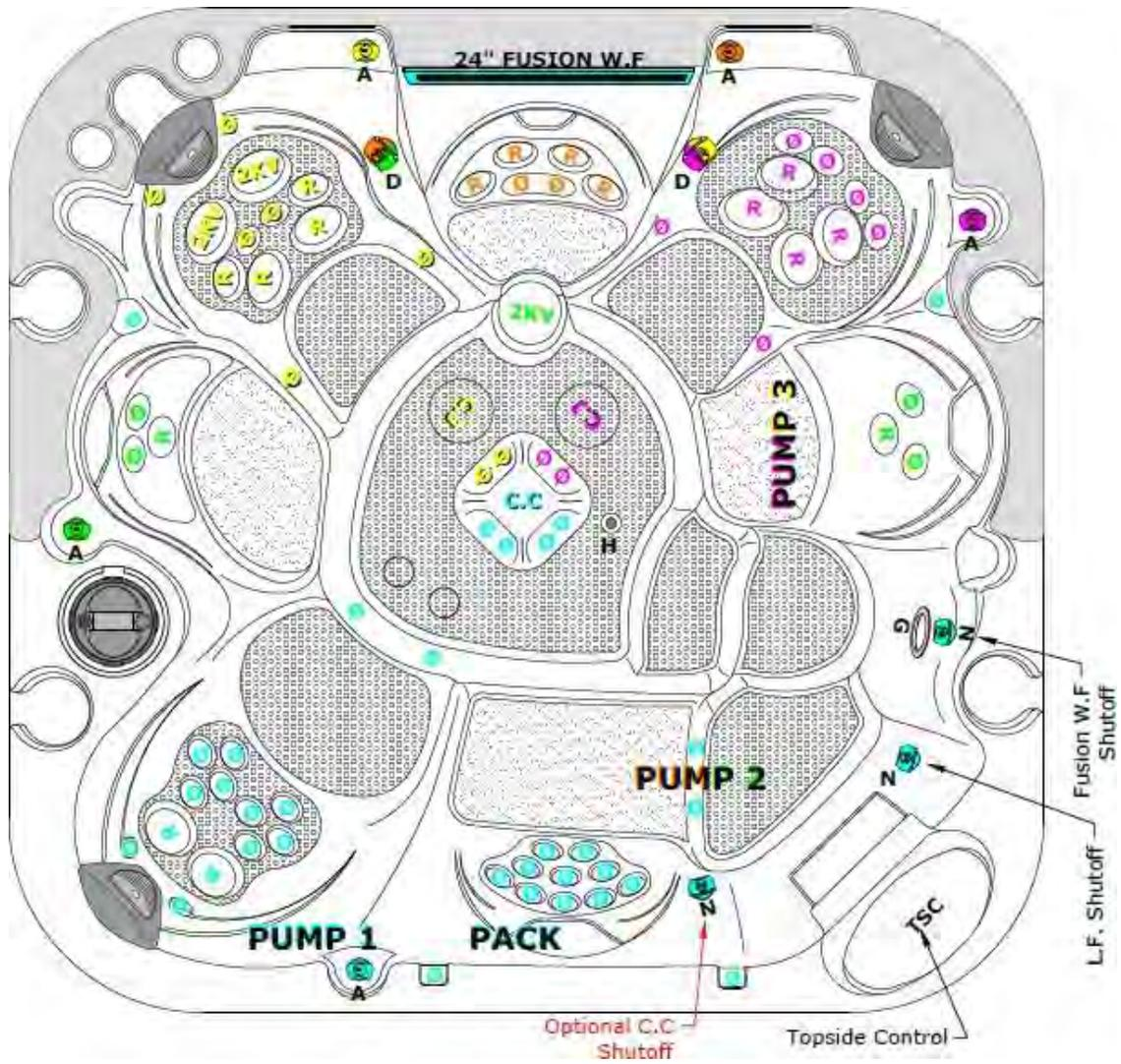

DISCLAIMER: At the time of print, this manual is accurate in its information. Coast Spas reserves all the rights to change/modify any spa designs and/or features without notification. To check on updates or for other information, please visit www.coastspas.com

LUXURY SPA JET OPERATIONS

LUXURY APEX LOUNGE CURVE 65 JETS

	PUMP 1
	PUMP 2
	PUMP 3

JET Note:

Ø	= Cluster Jet
R	= Poly Jet
2K	= Storm Jet
2KV	= Volcano Jet
C.J	= Carousel Jet

Wall Diverter Control

	= Green (Right)
	= Orange (Left)
(P2)	= Both (Center)
	= Yellow (Right)
	= Magenta (Left)
(P3)	= Both (Center)

Air Control General Note:

ON  **OFF**
 (BLUE, ORANGE, GREEN, MAGENTA, YELLOW)

Fusion W.F, L.F Shutoff & (Optional C.C Shutoff)

ON  **OFF**
 (BLUE)

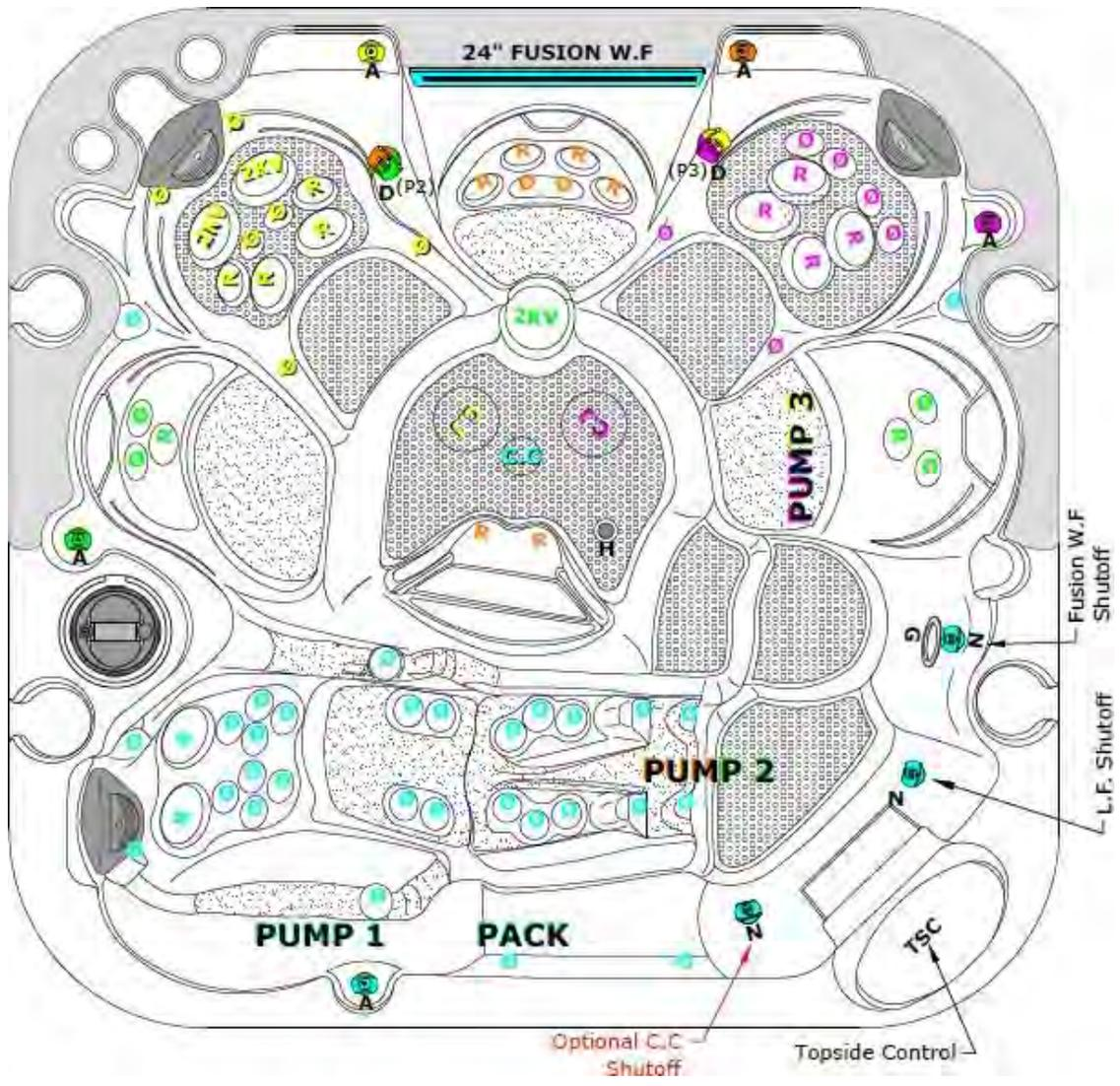

DISCLAIMER: At the time of print, this manual is accurate in its information. Coast Spas reserves all the rights to change/modify any spa designs and/or features without notification. To check on updates or for other information, please visit www.coastspas.com

LUXURY SPA JET OPERATIONS

LUXURY ELEMENT BENCH 60 JETS

	PUMP 1
	PUMP 2
	PUMP 3

JET Note:

∅	=	Cluster Jet
R	=	Poly Jet
2K	=	Storm Jet
2KV	=	Volcano Jet
C.J	=	Carousel Jet
C.C	=	Coast Connect

Diverter Control

	=	Orange (Right)
	=	Green (Left)
(P2)	=	Both (Center)
	=	Yellow (Right)
	=	Magenta (Left)
(P3)	=	Both (Center)

Air Control General Note:

ON  **OFF**
 (BLUE, ORANGE, GREEN, MAGENTA, YELLOW)

L.F Shutoff & (Optional C.C Shutoff)

ON  **OFF**

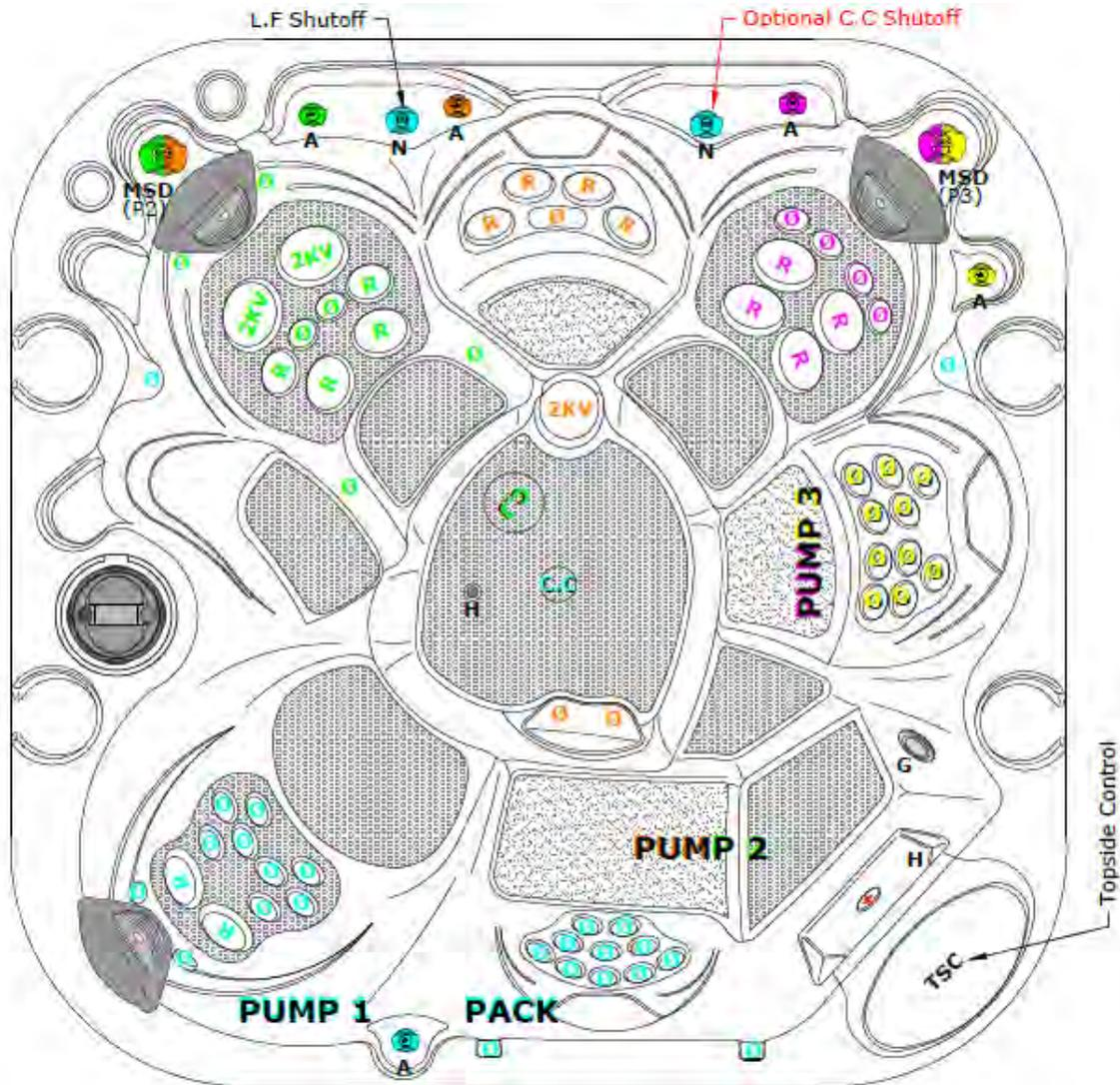

DISCLAIMER: At the time of print, this manual is accurate in its information. Coast Spas reserves all the rights to change/modify any spa designs and/or features without notification. To check on updates or for other information, please visit www.coastspas.com

LUXURY SPA JET OPERATIONS

LUXURY ELEMENT BENCH CURVE 60 JETS

	PUMP 1
	PUMP 2
	PUMP 3

JET Note:

Ø	= Cluster Jet
R	= Poly Jet
2K	= Storm Jet
2KV	= Volcano Jet
C.J	= Carousel Jet
C.C	= Coast Connect

Diverter Control

	= Orange (Right)
	= Green (Left)
(P2)	= Both (Center)
	= Yellow (Right)
	= Magenta (Left)
(P3)	= Both (Center)

Air Control General Note:

ON  **OFF**
 (BLUE, ORANGE, GREEN, MAGENTA, YELLOW)

Fusion W.F. & L.F Shutoff (Optional C.C Shutoff)

ON  **OFF**

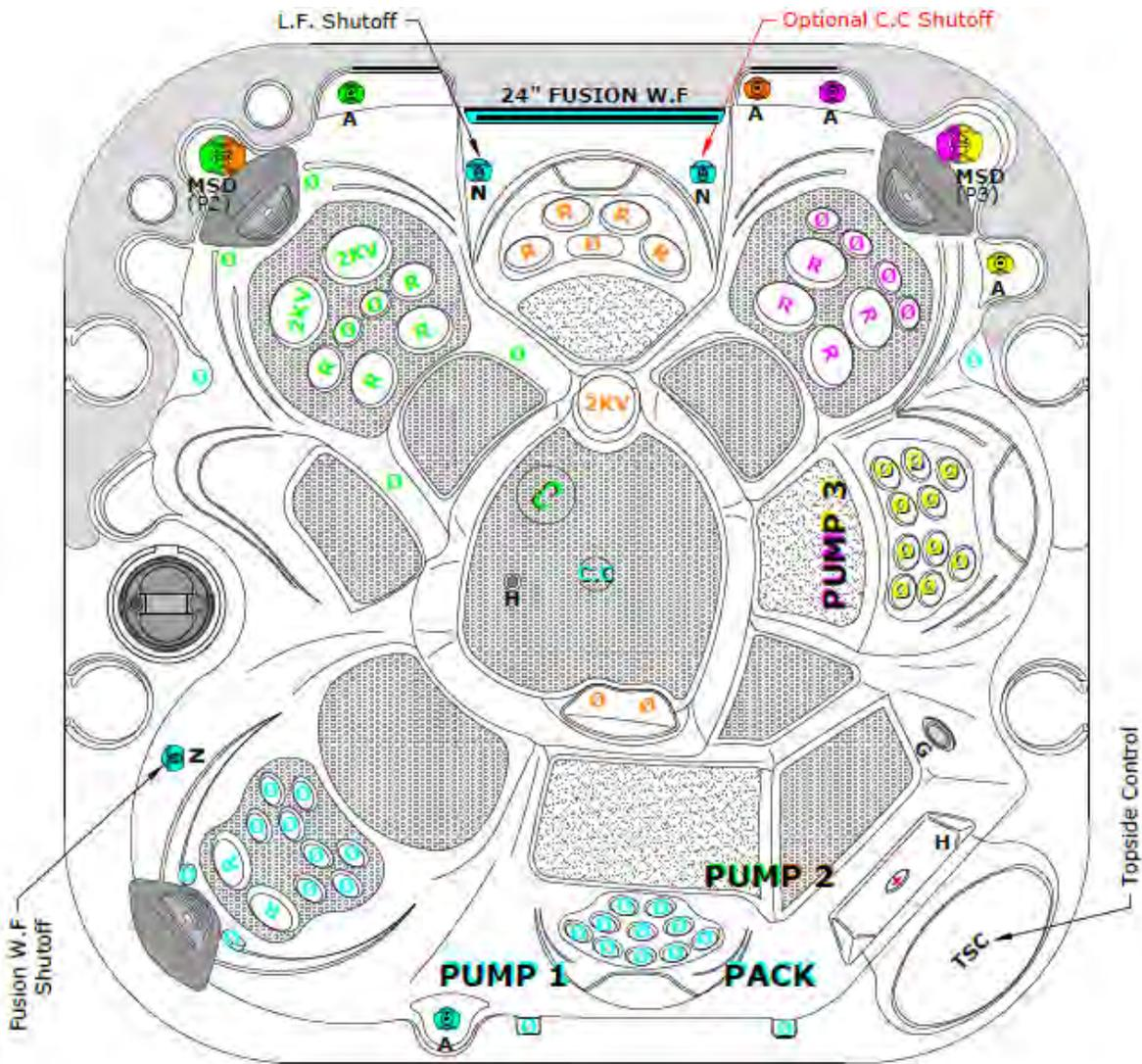

DISCLAIMER: At the time of print, this manual is accurate in its information. Coast Spas reserves all the rights to change/modify any spa designs and/or features without notification. To check on updates or for other information, please visit www.coastspas.com

LUXURY SPA JET OPERATIONS

LUXURY ELEMENT LOUNGE 60 JETS

	PUMP 1
	PUMP 2
	PUMP 3

JET Note:

∅	= Cluster Jet
R	= Poly Jet
2K	= Storm Jet
2KV	= Volcano Jet
C.J	= Carousel Jet
C.C	= Coast Connect

Diverter Control

	= Orange (Right)
	= Green (Left)
(P2)	= Both (Center)
	= Yellow (Right)
	= Magenta (Left)
(P3)	= Both (Center)

Air Control General Note:

ON  **OFF**
 (BLUE, ORANGE, GREEN, MAGENTA, YELLOW)

L.F Shutoff & (Optional C.C Shutoff)

ON  **OFF**

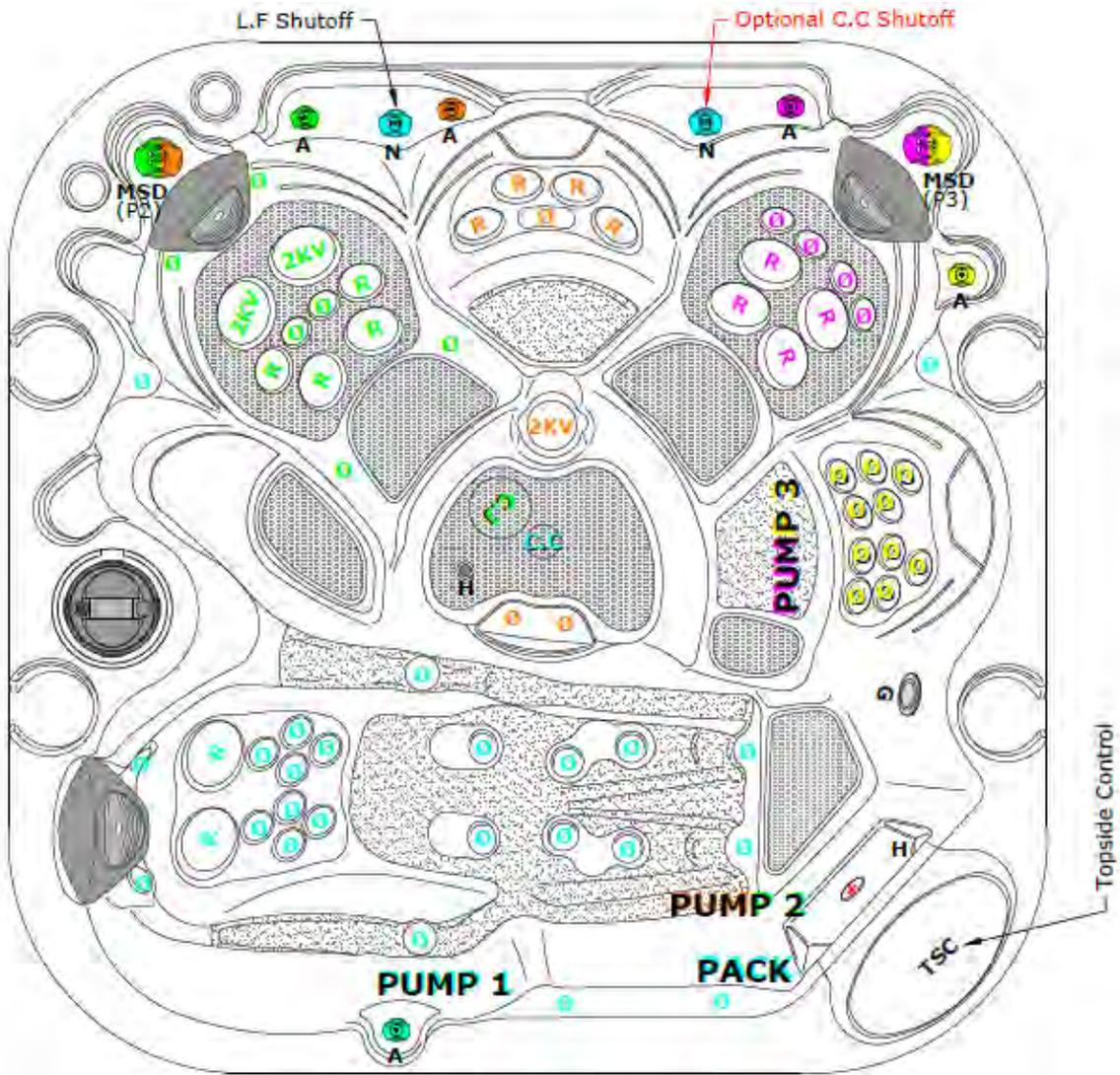

DISCLAIMER: At the time of print, this manual is accurate in its information. Coast Spas reserves all the rights to change/modify any spa designs and/or features without notification. To check on updates or for other information, please visit www.coastspas.com

LUXURY SPA JET OPERATIONS

LUXURY ELEMENT LOUNGE CURVE 60 JETS

	PUMP 1
	PUMP 2
	PUMP 3

JET Note:

Ø	= Cluster Jet
R	= Poly Jet
2K	= Storm Jet
2KV	= Volcano Jet
C.J	= Carousel Jet
C.C	= Coast Connect

Diverter Control

	= Orange (Right)
	= Green (Left)
(P2)	= Both (Center)
	= Yellow (Right)
	= Magenta (Left)
(P3)	= Both (Center)

Air Control General Note:

ON  **OFF**
 (BLUE, ORANGE, GREEN, MAGENTA, YELLOW)

Fusion W.F. & L.F. Shutoff (Optional C.C Shutoff)

ON  **OFF**

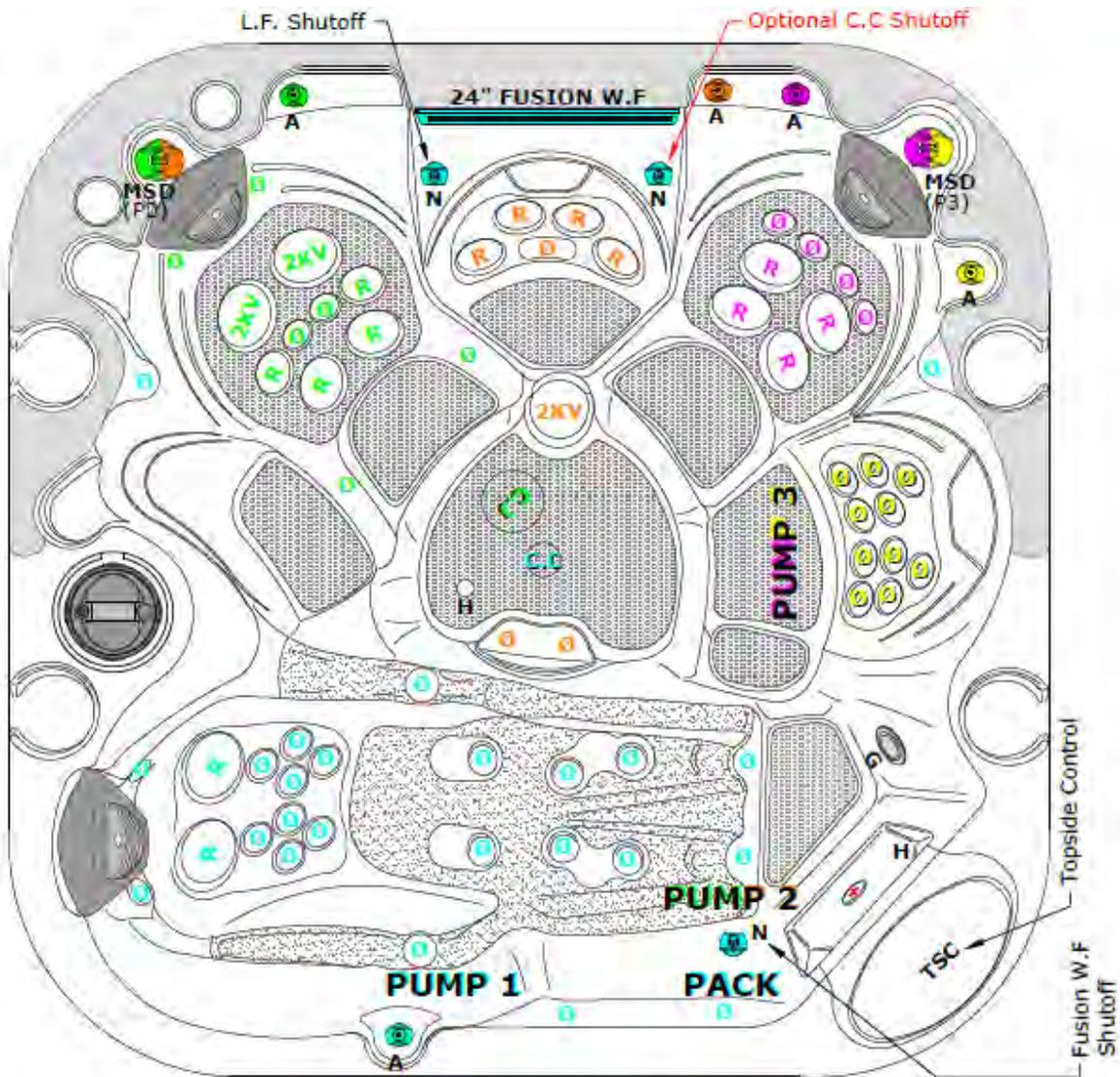

DISCLAIMER: At the time of print, this manual is accurate in its information. Coast Spas reserves all the rights to change/modify any spa designs and/or features without notification. To check on updates or for other information, please visit www.coastspas.com

LUXURY SPA JET OPERATIONS
LUXURY MIRAGE CURVE 65 JETS

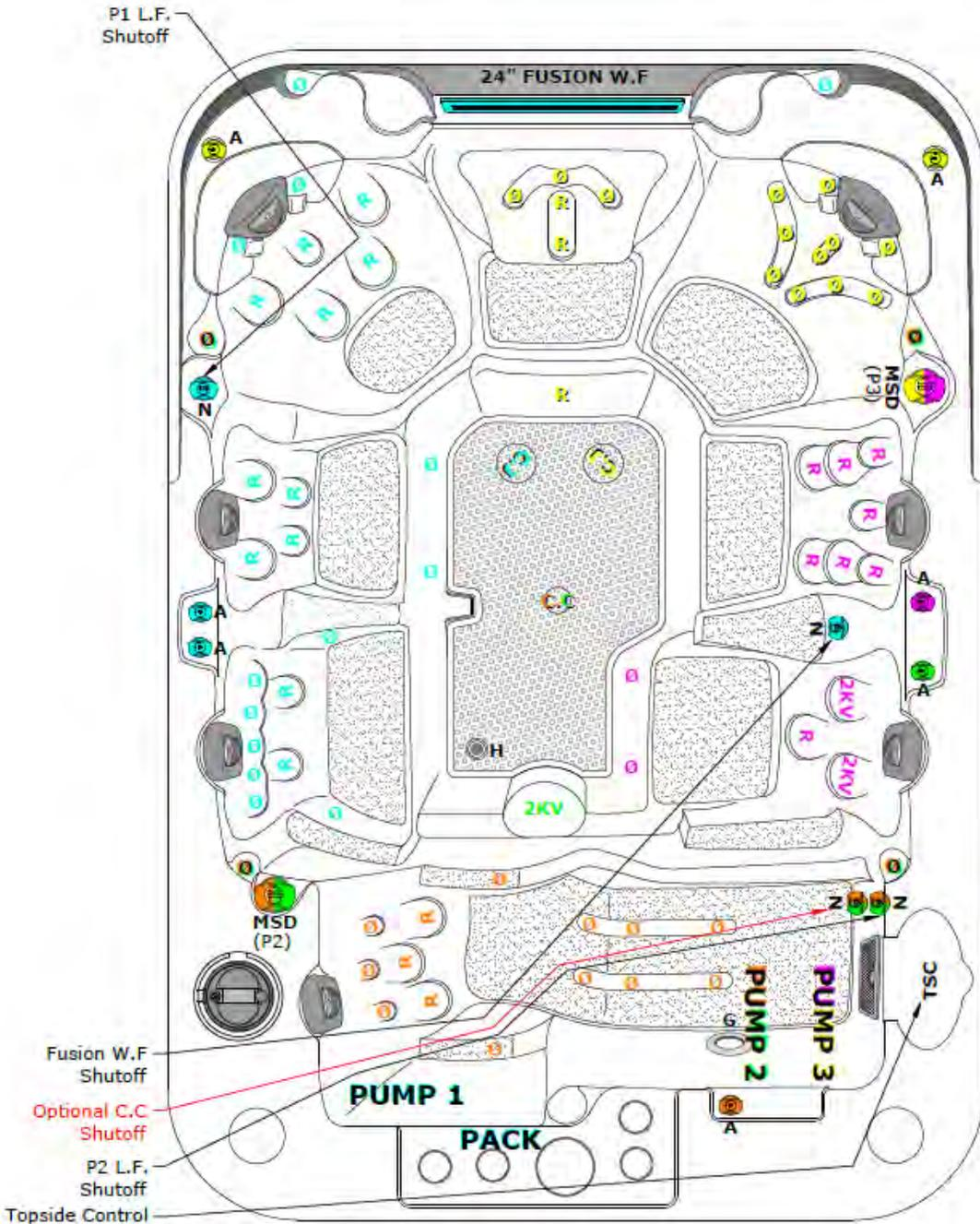

	PUMP 1
	PUMP 2
	PUMP 3

Air Control General Note:

ON (⊙) **OFF**
(BLUE, ORANGE, GREEN, MAGENTA, YELLOW)

JET Note:

- ∅ = Cluster Jet
- R = Poly Jet
- 2K = Storm Jet
- 2KV = Volcano Jet
- C.J = Carousel Jet

Diverter Control

- = Green (Right)
- = Orange (Left)
- (P2) = Both (Center)
- = Magenta (Right)
- = Yellow (Left)
- (P3) = Both (Center)

Fusion W.F. & P1 L.F. Shutoff

ON (⊙) **OFF**
(BLUE)

P2 L.F. Shutoff & (Optional C.C. Shutoff)

ON (⊙) **OFF**
(GREEN & ORANGE)

DISCLAIMER: At the time of print, this manual is accurate in its information. Coast Spas reserves all the rights to change/modify any spa designs and/or features without notification. To check on updates or for other information, please visit www.coastspas.com

BALBOA WI-FI MODULE

With the Balboa Wi-Fi Module installed in your spa follow the steps below to setup/configure the device.

Step 1: Download the app from the Google Play store or the iTunes store. The app will be titled “Coast Spas—Spa Remote” (Google) or Coast Spas—Remote Spa Control (iTunes).

Step 2: Make sure your Wi-Fi on your device is enabled. Check your device's instructions on how to access Wi-Fi Settings.

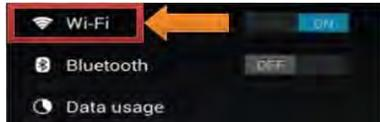

Selecting “Controls” will open a list of installed components like pump(s), blower, lights, etc.

Note: This screen will vary depending on installed components.

Selecting “Settings” will open the settings menu. While connected to the spa will be able to set the temperature, change the degrees between °F or °C, alter the heat mode (Ready/Rest), select the temperature range (low or high), set the time of day, input filter cycles (time start and duration) and have access to the advanced menu.

For more information on the various settings please refer to the selection in the owner's manual for your topside control.

Connecting to the Home Network

Note: You can only connect the Wi-Fi app to the house network when connected directly to the Wi-Fi Module. See “Getting Started” to connect directly to the Wi-Fi Module.

Once connected to the Wi-Fi Module navigate to:
Settings ► Advanced ► Wi-Fi Settings

Step 3: While standing at the spa select the Wi-Fi Module from the list of available devices from your device's Wi-Fi menu. The Wi-Fi device will appear as BWGSpa_XXXXX in the list.



Step 4: Once connected to the Wi-Fi Module, directly open the Coast Spas app. The Coast Spas app will allow you to control and interact with the spa while you are still within range.



Step 5: Select your router's security setting. This will vary and if the wrong setting is selected the app will not be able to access the spa.

Step 6: Set up your home network. Each router will have its own unique SSID (Service Set Identifier).

Step 7: Enter your key. The key will be the pass key used to sign in on your network.

Note: If you do not know or need assistance locating any of the information above, please contact your local service provider.

CONTROLMYSPA™

CMS™ SYSTEM CONSISTS OF:



WEBSITE

ControlMySpa™ website with Login and access to spas

CMS™ GATEWAY ULTRA Modules



Home Module



Spa Module

www.balboawater.com/GatewayUltra

SMARTPHONE | TABLET



iOS (Apple) ControlMySpa™ mobile app and/or Android ControlMySpa™ Mobile app

The ControlMySpa™ system consists of:

- ControlMySpa™ GATEWAY ULTRA installed on a spa/Hot Tub
- iOS (Apple) ControlMySpa™ mobile app or Android ControlMySpa™ mobile app
- ControlMySpa™ website with log-in and access to spas

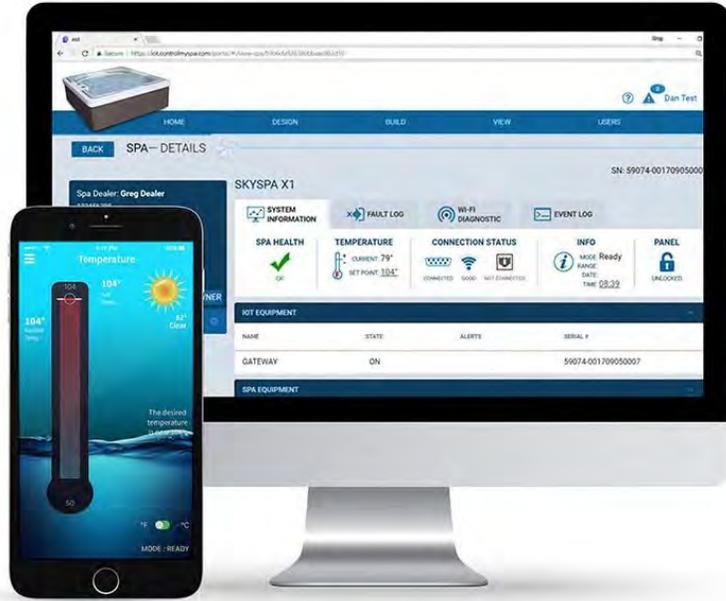

The ControlMySpa™ Logins:

- The iOS or Android ControlMySpa™ apps can only be accessed with an owner log-in
- The ControlMySpa™ website can be accessed with an owner log-in.

FOR ANDROID® PHONES/TABLETS
 Search Google Play App Store for “controlmyspa”
 Or use this link: <https://goo.gl/CG4Yci>.



ControlMySpa™

Connect GATEWAY ULTRA hardware in your home

Step 1

Plug the supplied Ethernet cable into the home router (A).

Step 2

Plug the other end of the Ethernet cable into the GATEWAY ULTRA module (B).

Step 3

Plug the supplied power cord into the GATEWAY ULTRA module (C).

Step 4

Plug the other end of the supplied power cord into wall power (D).



GATEWAY ULTRA Module (side view)

LED Light Chart (E)

This chart applies to the home and spa GATEWAY ULTRA modules.

-  Red - Solid: The GATEWAY ULTRA and the spa are not connected.
-  Red - Blinking: Home and spa GATEWAY ULTRA modules are connected, but no connection to the spa controller.
-  Blue - Blinking: Remote software update is underway. Do not unplug power.
-  Green - Blinking: CMS™ GATEWAY ULTRA spa and home modules RF is connected, but no connection to internet.
-  Green - Solid: Spa successfully connected to internet. No errors.

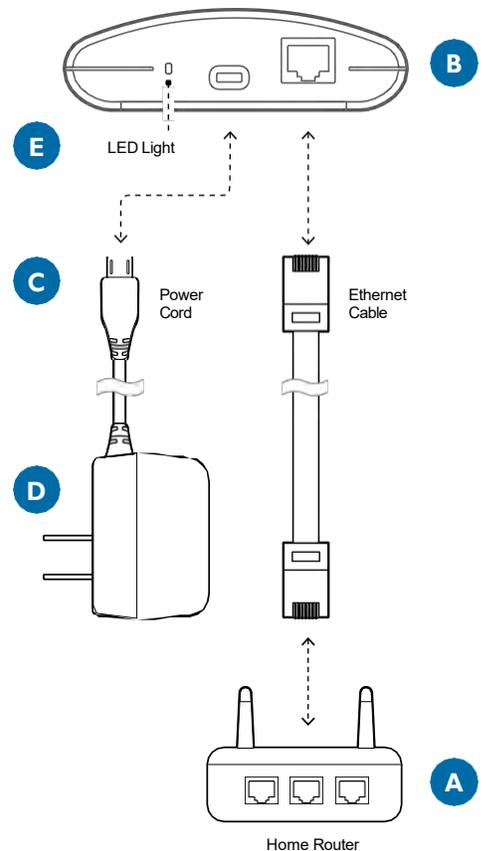

CMS™ Code Overview

WHAT IS A CMS™ CODE?

- CMS™ Code is an 8-digit letter/number combination that all Spa owners must have to use spas equipped with the ControlMySpa™ system.
 - A) The CMS™ code is obtained from your Dealer.
- Spa owners will need this CMS™ code to setup and connect their spas in the ControlMySpa™ database.
- The CMS™ code connects your spa to your OEM and Dealer for service and support.

EXAMPLE CMS™ Code: ABC-12345

ABC = 3 letter code unique to each spa Manufacturer or OEM **12345** = 5 number code unique to each spa Dealer or Distributor

ControlMySpa™

Setup Spa Owner User Account



1. Open the app on your smart device.

Press "SETUP" on the app.



2. Press "Next"

Confirm Bluetooth is ON in the iOS Settings.



3. Press "Next"

Stand near your spa (within 10 feet/3 meters) and ensure the spa power in ON by pressing the topside panel. If the spa is powered ON, press "Next".

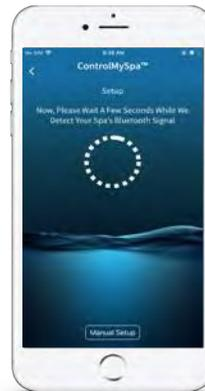

4. Detect Bluetooth



5. Press "Yes"
The serial number in the app should match the serial number on the back of the spa module.

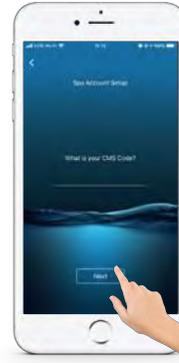

6. Press "Next"
The CMS code is provided by your Dealer. Press "Next".



7. Press "Next"
Input information and press "Next".



8. Press "Next"
Input information and press "Next".



9. Press "Next"
Input information and press "Next".



10. Press "Next"
Your UserID and password will appear. Press "Next".



11. Press "Close"



12. Press "SIGN IN"
Input your email address, password, and press "SIGN IN".

SUCCESS! YOUR ACCOUNT IS SETUP, AND YOU CAN CONTROL YOUR SPA WITH THE CMS APP.

BALBOA BLUETOOTH AUDIO



bba3 Amplifier

Control System

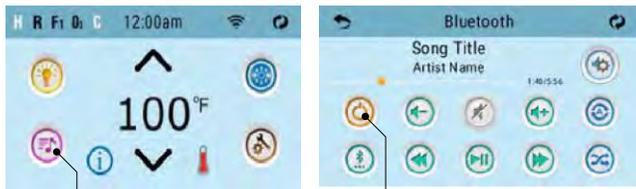

Music Button

Power Button

Pairing Smart Device

- Power up the system pack with bba2 already connected to the system pack.
- On the control panel press the music button. Next, press the power button.
- Turn on Bluetooth function of your smart device or music device.
- On your smart device or music device, click search for Bluetooth device. Make sure you are close enough to the spa tub.
- On your smart device, select "BBA Spa Music" from the pairing list. If "BBA Spa Music" does not appear, repeat steps previous steps.
- Some smart devices will connect automatically and others you will need to select "Connect." Once connected, this icon will appear. Play music on your smart device. If the music plays from the speakers in the spa, the connection is complete.

NOTE: bba3 operates up to 100 feet in open air. Ranges vary as they depend on installations.

Bluetooth Screen

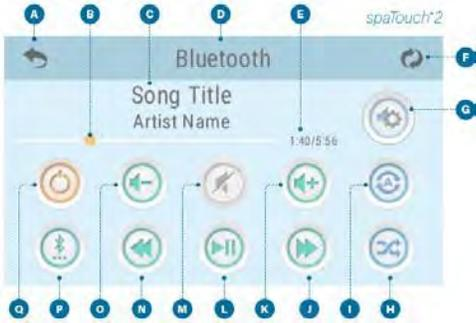

- | | |
|-----------------------------------|-------------------------------------|
| A - Back | J - Track Forward |
| B - Progress Bar | K - Volume Up |
| C - Song Title, Artist | L - Play/Pause |
| D - Screen Title: Bluetooth | M - Mute |
| E - Song Progress | N - Track Back |
| F - Invert Display | O - Volume Down |
| G - Settings | P - Input Modes: Bluetooth, Line in |
| H - Shuffle | Q - Power |
| I - Repeat: one song or all songs | |

Adjust Settings



1. Follow these steps to adjust the audio settings. Press the Music button (A) to enter the Bluetooth screen.
2. Press the Settings button (B) to enter the Settings screen.
3. Press these buttons (D) to select an audio setting. The audio settings are listed below.
4. Press these buttons (C) to change the setting's value.

SETTINGS

- Balance
- Fade
- EQ Preset
- Filter
- Bass Gain

There are two types of filters: Low Pass and High Pass. These filters apply to the rear speaker output only. Select Low Pass for subwoofers or High Pass for tweeters. Select OFF if filtering is not desired. Normal speakers do not require filtering.

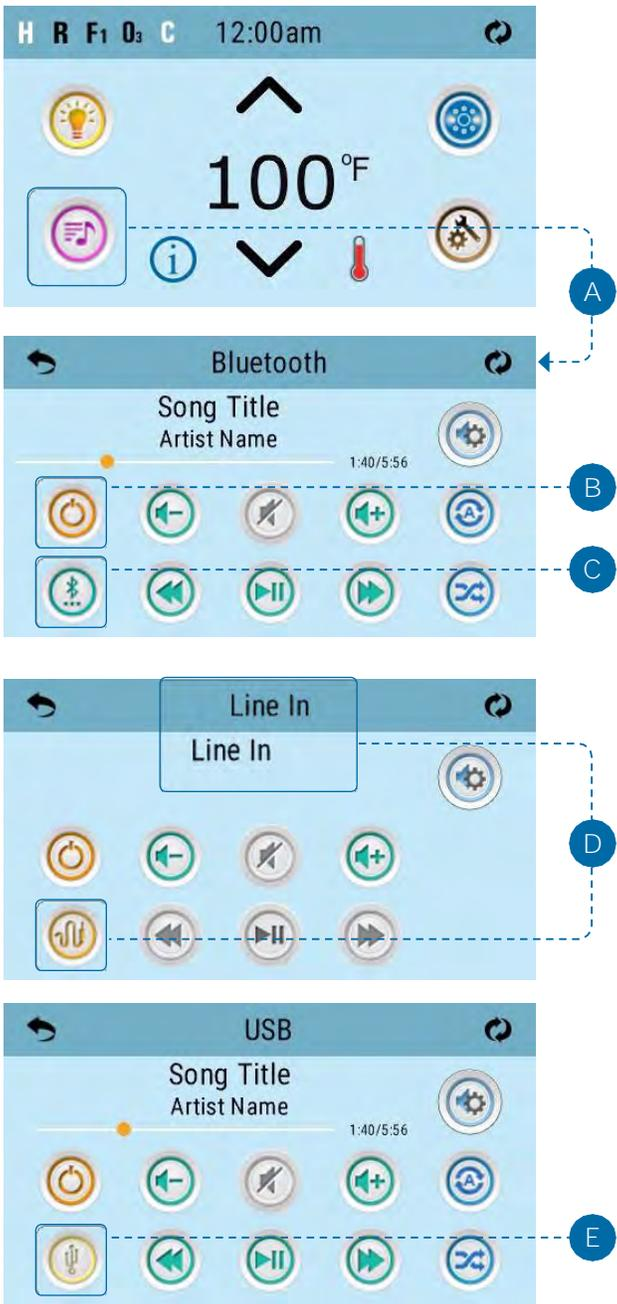

bba™3 Amplifier

SELECT INPUT MODE

The following input modes are available: Bluetooth, Line In. All control systems are equipped with Bluetooth mode. However, control systems may or may not have Line In, as this input mode is optional.

Follow these steps to select the input mode of the bba™3 amplifier.

1. Press the Music button (A) to enter the Bluetooth screen.
2. Confirm that the bba™3 amplifier is turned On. If it is turned Off, the button icon (B) will be gray.
3. Press the Input button (C) to select one of the following input modes:

Bluetooth (C).

Line In (D)

USB (E) - USB is not available with the bba™3 amplifier, even though the icon may appear on the panel.

Line In mode (D) allows you to connect any headphone output to the Aux In connectors (F), but you will likely need an adapter cable because of the different connectors.

Only audio settings such as Volume are available when using Aux In (F).

The terms "Line In" (D) and "Aux In" (F) refer to the same thing.

INPUT MODE ICONS

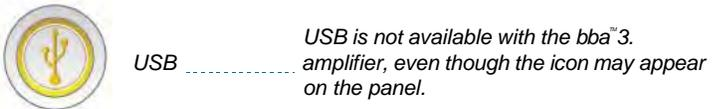

TROUBLESHOOTING

Scenario 01

Problem: The error message “BT Comm Lost” (A) appears on the panel display.

Solution: The control system has lost communication with the bba™3 amplifier (B). Contact customer support for help.

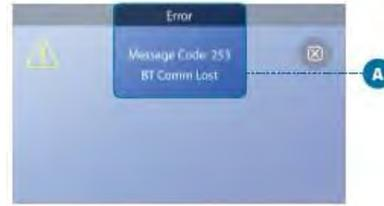

Scenario 02

Problem: When you try to connect your music device to Aux In on the bba™ amplifier, the Aux In connectors on your bba™ amplifier are different than these (C).

Solution: Your spa is equipped with an earlier version of bba™ (1 or 2). Contact customer support for help.



Scenario 03

Problem: Song titles appear only sometimes or never.

Solution 1: A few music player apps never send song titles and other info over Bluetooth, so try another app. Also, some music player apps don't send song title if playing automatically in the background, only if the app is “visibly running” on the device, so try “opening” the app which is playing in the background.

Solution 2: If the song title never appears, this can happen for a couple of other reasons. One, you may have an older bba™ amplifier. Two, you may have an older panel. Contact customer support for help.



Scenario 04

Problem: When you press the music button (A) or select A/V, it does not go to the Bluetooth screen.

Solution: If the screen it takes you to has a Bluetooth button (B), select that Bluetooth button to continue.

That Bluetooth button (B) may not appear if the control system (E) did not detect the bba™3 amplifier (D).

NOTE: This can appear on multiple panels. The spaTouch™2 screens on this page are used to illustrate the scenario.

Scenario 05

Problem: The Shuffle and Repeat buttons do not work on my panel.

Reason: Some music players/devices do not support Shuffle and/or Repeat.

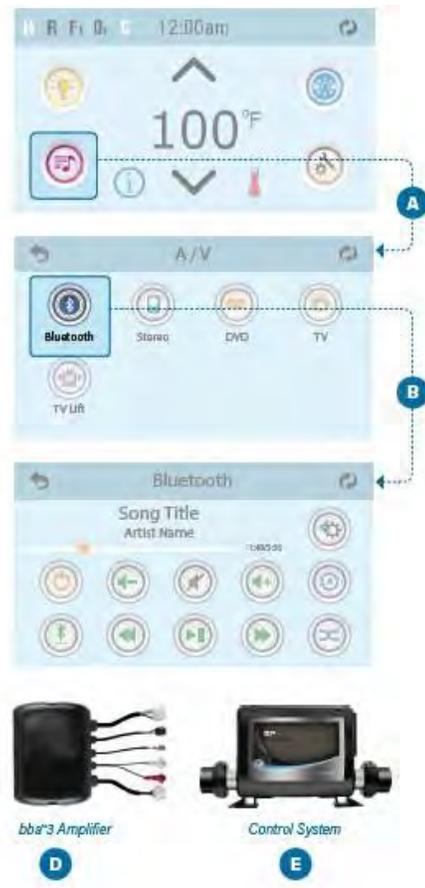

COAST STATUS



Compatible with BP Spa Packs:

North American (NA) Packs: 56689-03 and 56683-05

European (EU) Packs: 56688-04 and 56690-03

Coast Status is designed to give real time status of the spa. LED's will be tied to a cabinet mounted light fitting that the spa owner can use to tell, at a glance, if all is OK with the spa or if something requires their attention. Coast Status Warning messages shown below.

Coast Status Lighting Legends



Steady Blue Light

Spa pack is operational. There are no messages, faults, or error codes.



Flashing Blue Light

Spa pack is operational. There is a reminder and/or message. There is no fault. *Example: Message code 40 - this code requests you to set the time.*

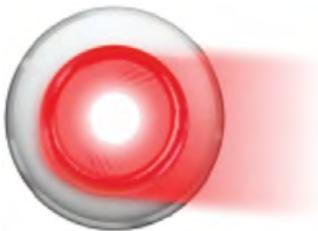

Steady Red Light

There are warning messages or faults present.



Flashing Red Light

Severe warnings or faults present.

To check message on the Control Panel screen, tap on  icon.

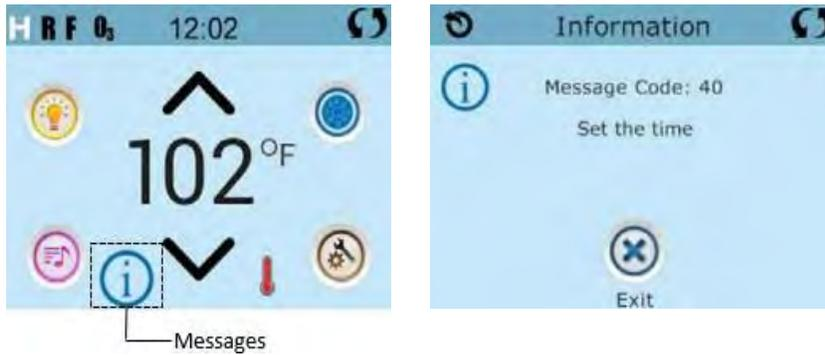

COAST STATUS MESSAGES

Message #	Message Text	Message #	Message Text	Message #	Message Text
0	<none>	20	The clock has failed	36	The GFCI test failed
1	Possible freezing condition	21	The settings have been reset	37	Hold (aka Standby) Mode
2	Test the GFCI	22	Program memory failure	38	Run Jets 1 to get temperature
3	Change the filter	23	Configuration error (Call for service)	39	Test software installed
4	Clean the filter	24	Darin Mode	40	Set the time
5	Treat the wood	25	Demo Mode	43	Change UV
6	Clean the cover	26	Sensors are out of sync (Call for service)	44	J29
7	Change the mineral cartridge	27	The heater is dry	45	The water level is too low
8	Change the water	28	The heater may be dry	47	Check Ozone
9	Check the sanitizer	29	The water is too hot	48	Service Check-Up
10	Check the pH	30	The heater is too hot	49	Check the filter now
15	Sensors are out of sync	31	Sensor A fault (Call for service)	248	Chromazon Fault: Too Many Lights
16	The water flow is low	32	Sensor B fault (Call for service)	250	Chromazon Fault: Not Responding
17	The water flow has failed	34	A pump may be stuck on	253*	BT Failure
19	Priming Mode	35	Hot fault (Call for service)	254*	Communications error (Call for service)

COAST SPAS ECOCLEAN UV STERILIZER



HOW IT WORKS

- Ultraviolet germicidal UV lamps are low pressure mercury vapor lamps which produce the UV-C dose necessary for microorganism's eradication.
- This dose (mJ/cm²) is the result of a design taking care of the flow rate, the water transmittance, reactor size and exposure time.
- Ultraviolet light is generated by an electrical discharge through low pressure inert gases and mercury vapor with the special quartz tube of the lamp.
- UV Rays generated at 254 Nm are germicidal at the optimal wavelength for eradicating micro-organisms.
- Eradicates organisms that can live in a chlorinated environment.
- Your EcoClean UV Sterilizer imparts nothing into the water, making it an eco-friendly, reliable, and effective choice.
- The sterilizers UV Bulb should be replaced, and its protective quartz tube cleaned every 18 months.
- The UV-C rays of our sterilizer take care of in-line sanitation. However, weekly shocking of the water is advisable to oxidize any chloramines or contaminants. An ozonator is also recommended as an excellent complimentary device for oxidation.

EASY MAINTENANCE

- Your NEW Coast Spas EcoClean UV Sterilizer is installed out of sight, concealed by your spa skirt. Quick access is gained through simply removing one skirt panel.
- Replacement of the UV lamp: Every 13 000 operating hours
- Clean quartz tube at time of lamp replacement (12 to 18 months)
- Remember to keep the recommended free residual of chlorine or bromine in the water as required in your specific region (Canada 3 to 5 ppm of chlorine or bromine).
- Made in the U.S.A (UL/CE/EPA Approved)

QUICK FACTS

- The unique quartz tube of the EcoClean UV Sterilizer blocks out all but UV-C 254 Nm rays. Any less and a sterilizer is less effective for spas. Similarly, if a sterilizer exceeds this intensity, it will break down chlorine or bromine and be less effective as a result.
- Although you should keep your spa water balanced, balancing chemicals do not alter the effectiveness of the sterilizer, as it neutralizes 99.9% of viruses and bacteria.
- Because the EcoClean UV Sterilizer is eliminating chloramines and organisms in-line, the free chlorine or bromine, of which you still must maintain recommended levels, is more efficient – you can save up to 70% in sanitizing chemical use.



WORLD'S BEST BUILT SPAS